

QuSpot for Robustel R151x

INTEGRATED MULTI-BAND 5G OMNI ANTENNA + WI-FI 6E OMNI ANTENNA + POE SPLITTER + PLACE TO INSTALL ROBUSTEL R151X (ALL-IN-ONE)

QuSpot antenna for Robustel R151x router is a perfect outdoor device for mobile and fixed installations like industrial, CCTV, hotspots, yachts, boats, campers, RV etc. It has embedded omni 5G and omni Wi-Fi 6E antenna. If you use R151x with QuSpot antenna, you get an integrated complete solution with embedded router and multi band antennas in one enclosure.

Wi-Fi 6E support!

The set contains a [Passive PoE splitter](#), allowing you to split data and power from a single Ethernet cable and maintain gigabit transfer speeds while protecting the LAN port from damage caused by overvoltage, short circuit or improper connection.



OUTDOOR ANTENNA WORKS IN ANY WEATHER CONDITIONS, IP67



GALVANIZED STEEL, WALL OR POLE MOUNTING BRACKET



WIDE BAND 600-6000MHZ, 5G TECHNOLOGY



ANTENNA PERFECTLY MATCHED WITH THE ROBUSTEL R151X



ALL ANTENNAS AND ROBUSTEL ROUTER INTEGRATED IN ONE ENCLOSURE

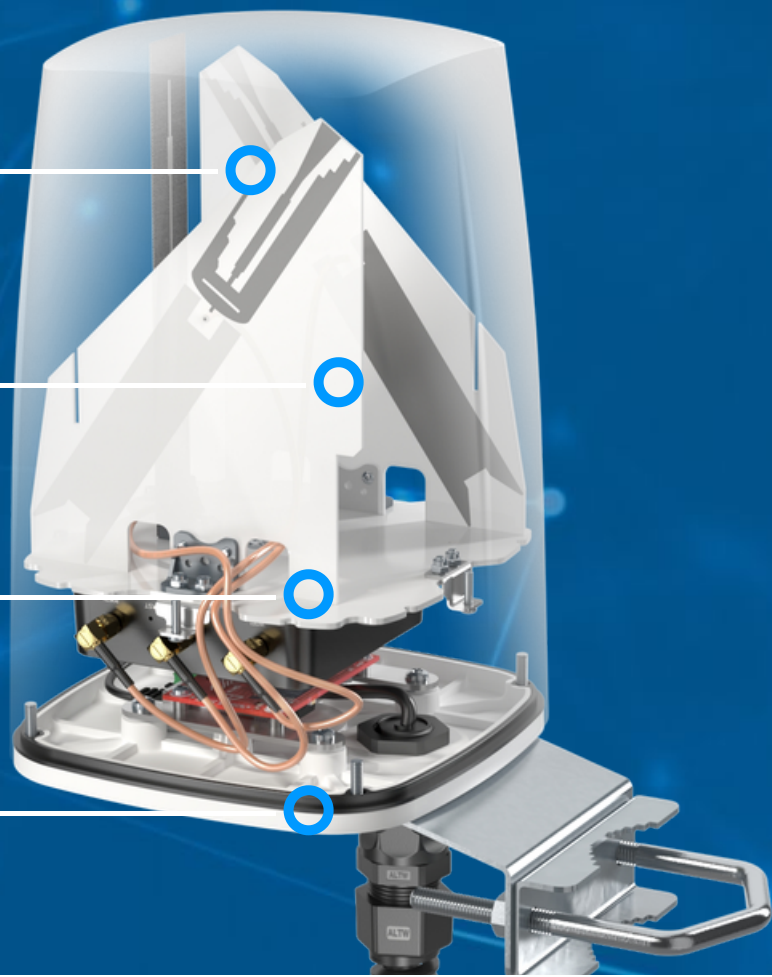

5G / LTE ANTENNA SPECIFICATION

FREQUENCY	617 - 960 MHz 1.7 - 2.7 GHz 3.3 - 4.7 GHz 5.2 - 6.0 GHz
GAIN	617 - 960 MHz : 3 dBi 1.7 - 2.2 GHz : 4 dBi 3.3 - 4.7 GHz : 4.5 dBi 5.2 - 6.0 GHz : 2.5dBi
SUPPORTED LTE BANDS	1, 2, 3, 4, 5, 7, 8, 9, 10, 12, 13, 14, 17, 18, 19, 20, 22, 25, 26, 27, 28, 29, 30, 33, 34, 35, 36, 37, 38, 39, 40, 41, 42, 43, 44, 47, 48, 49, 52, 53, 65, 66, 67, 68, 69, 71, 85, 103, 106
SUPPORTED 5G BANDS	n1, n2, n3, n5, n7, n8, n12, n13, n14, n18, n20, n25, n26, n28, n29, n30, n34, n38, n39, n40, n41, n47, n48, n53, n65, n66, n67, n71, n77, n78, n80, n81, n82, n83, n84, n85, n86, n89, n90, n95, n97, n98, n100, n101, n256
VSWR	<1.80, max <2.00
BEAMWIDTH	360°/35° ±5°
POLARIZATION	Vertical
IMPEDANCE	50 Ω

WI-FI ANTENNA SPECIFICATION

FREQUENCY	2.4 - 2.5 GHz 5.0 - 7.2 GHz
GAIN	2.4 - 2.5 GHz: 6dBi 5 GHz: 7.5dBi 7 GHz: 7.5dBi
VSWR	< 1.50, max < 2.00
BEAMWIDTH	360°/25°
POLARIZATION	Vertical
IMPEDANCE	50 Ω

MECHANICAL SPECIFICATION

MATERIALS	ABS, aluminum, PTFE
CONNECTOR TYPE	RJ45
INGRESS PROTECTION	IP67
DIMENSIONS	160 x 160 x 240 mm 6.3 x 6.3 x 9.45 inch
WEIGHT	1.5 kg 3.31 lbs
OPERATING TEMPERATURE	From -40°C to 80°C From -40°F to 176°F
MAST DIAMETER	40-60 mm 1.57-2.36 inch

FREQUENCY BANDS

LTE / 4G

	1	2	3	4	5	7	8	
	9	10	12	13	14	17	18	
	19	20	22	25	26	27	28	
617 MHz	29	30	33	34	35	36	37	6000 MHz
	38	39	40	41	42	43	44	
	47	48	49	52	53	65	66	
	67	68	69	71	85	103	106	

5G

	n1	n2	n3	n5	n7	n8	n12	
	n13	n14	n18	n20	n25	n26	n28	
	n29	n30	n34	n38	n39	n40	n41	
617 MHz	n47	n48	n53	n65	n66	n67	n71	6000 MHz
	n77	n78	n80	n81	n82	n83	n84	
	n85	n86	n89	n90	n95	n97	n98	
	n100	n101	n256					

PLOTS

LTE VSWR

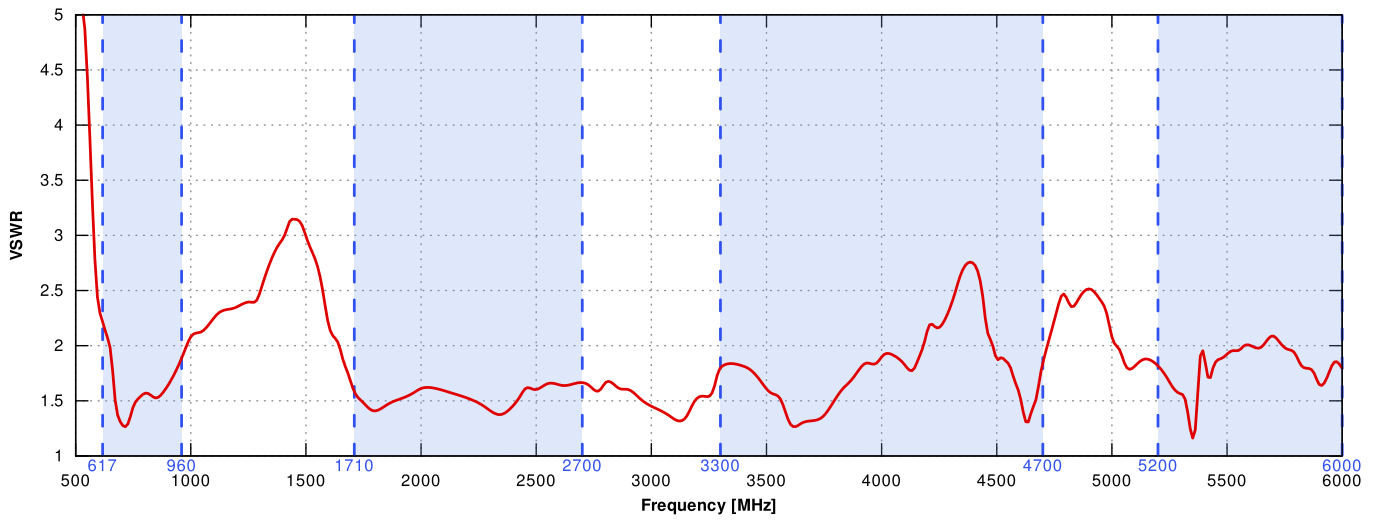

LTE Gain

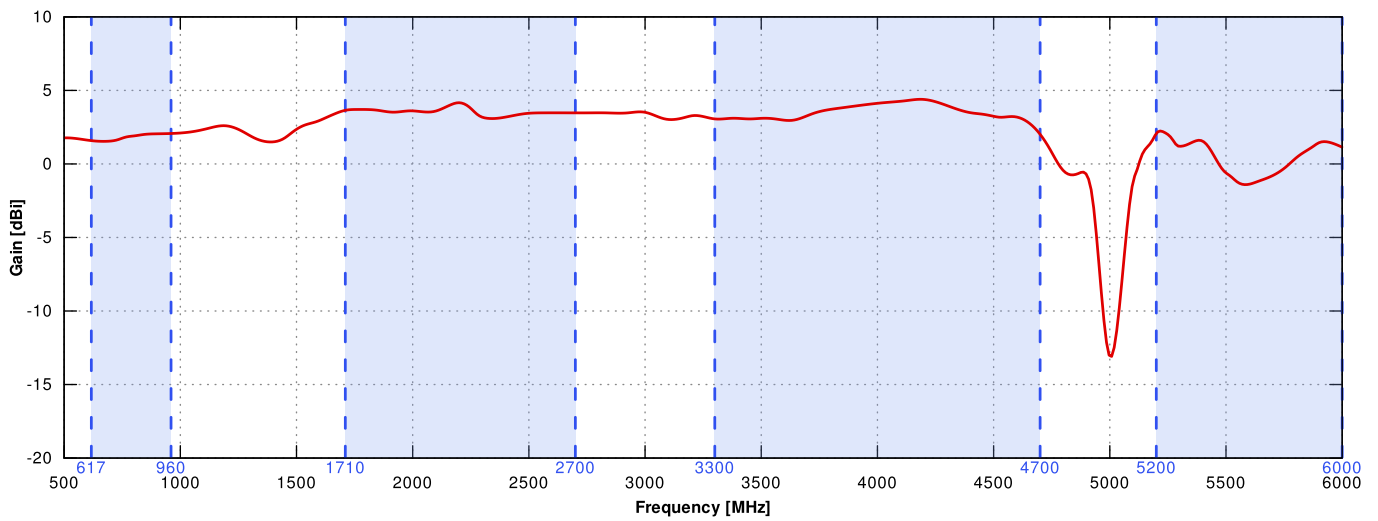

WI-FI VSWR

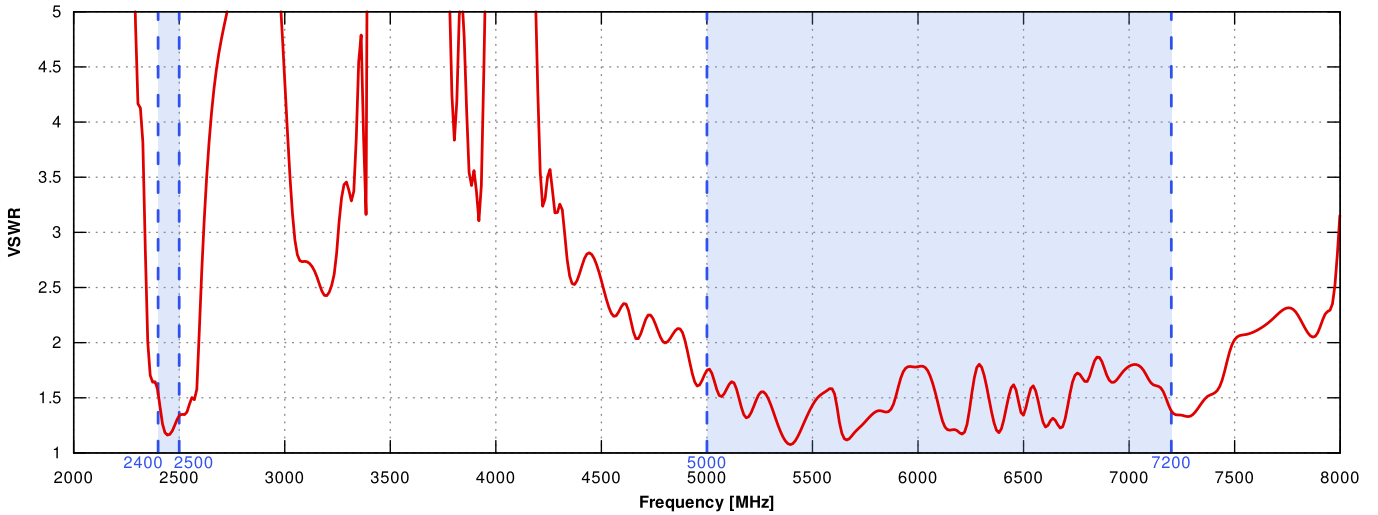

WI-FI Gain

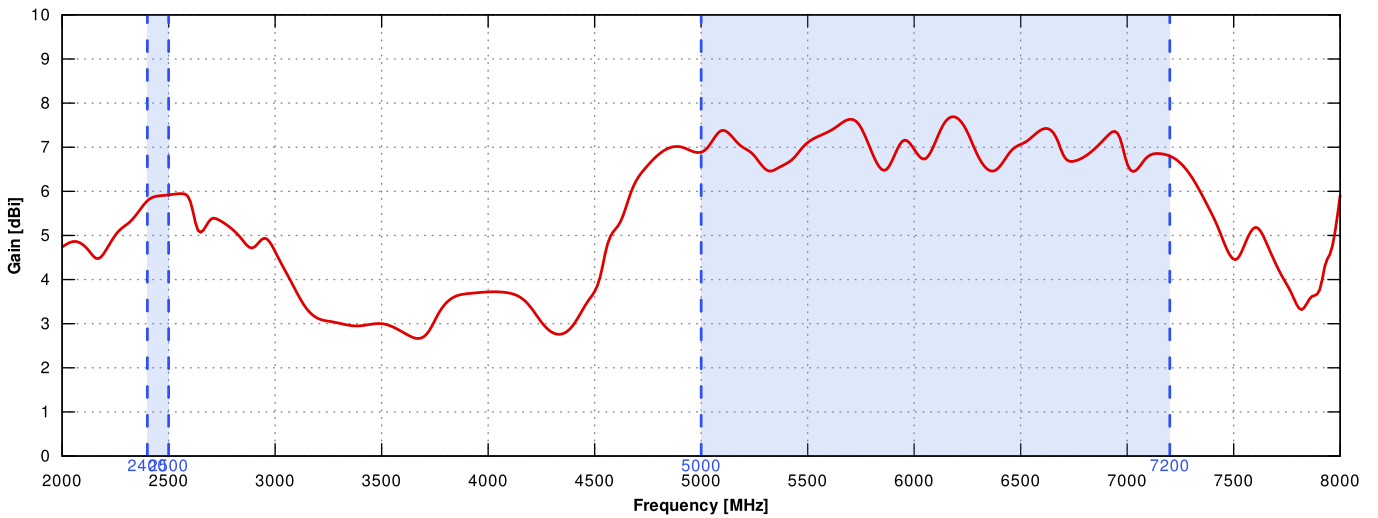

LTE From 617MHz to 960MHz

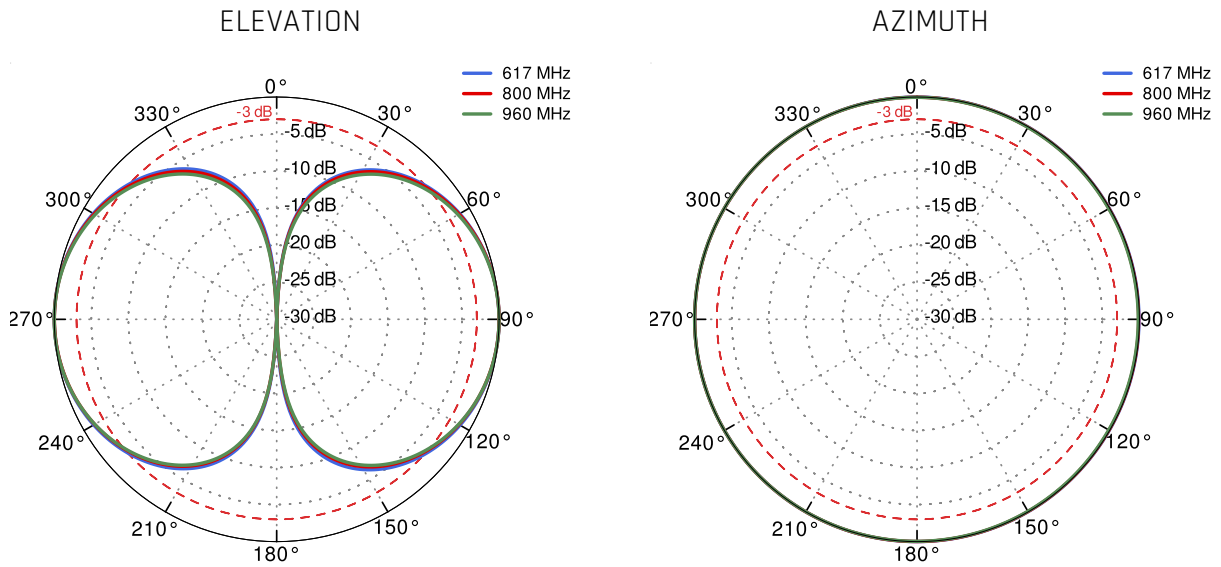

LTE From 1.71GHz to 2.5GHz

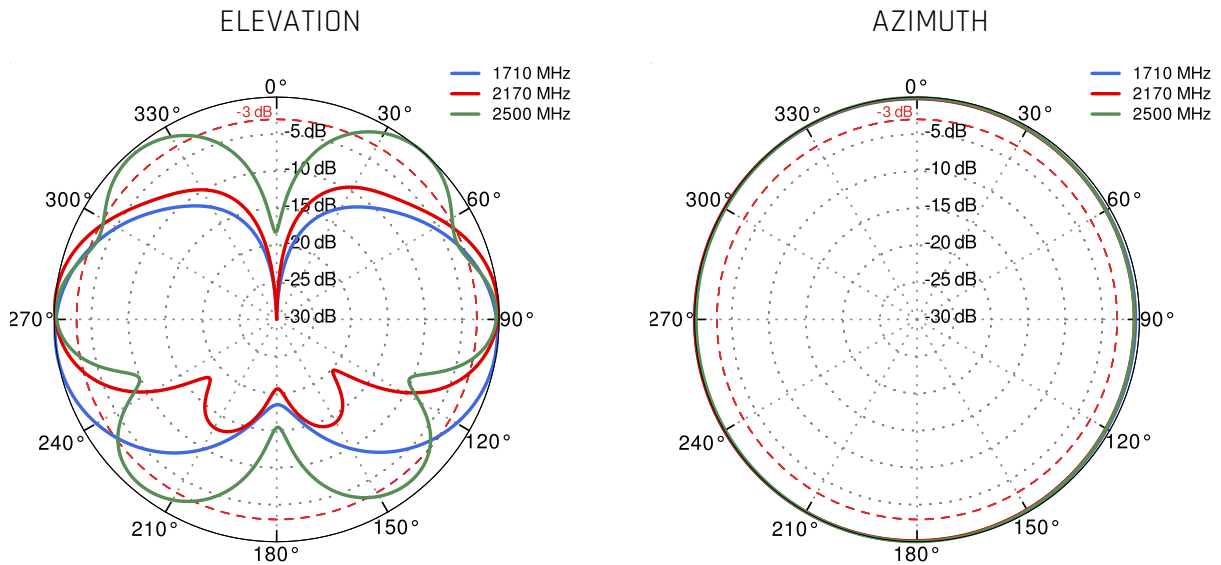

LTE From 3.3GHz to 4.2GHz

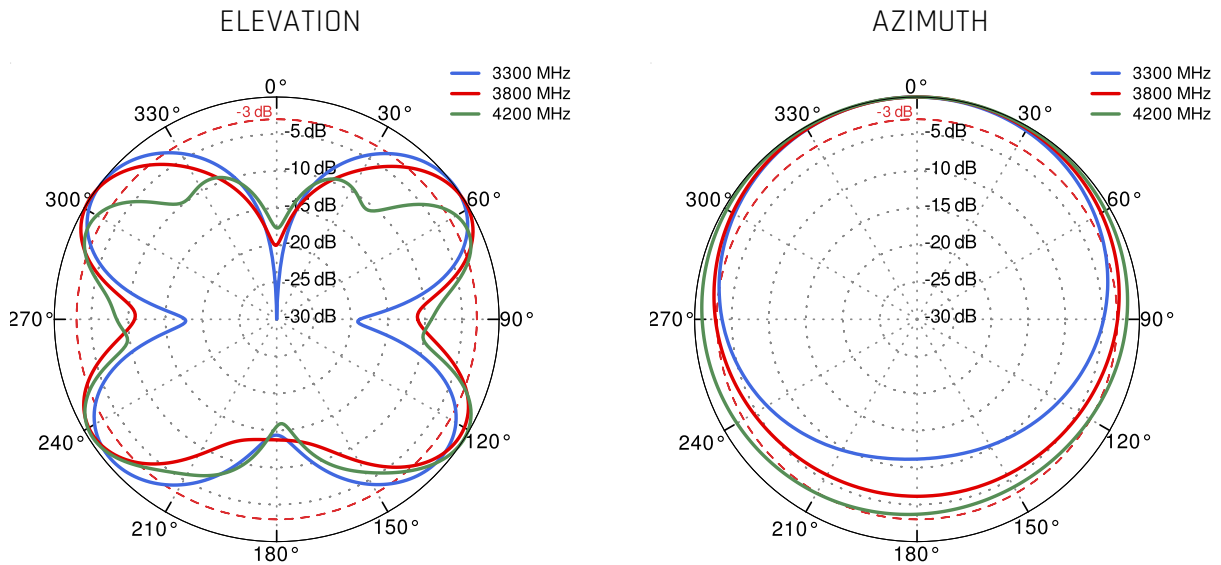

LTE From 4.6GHz to 5.5GHz

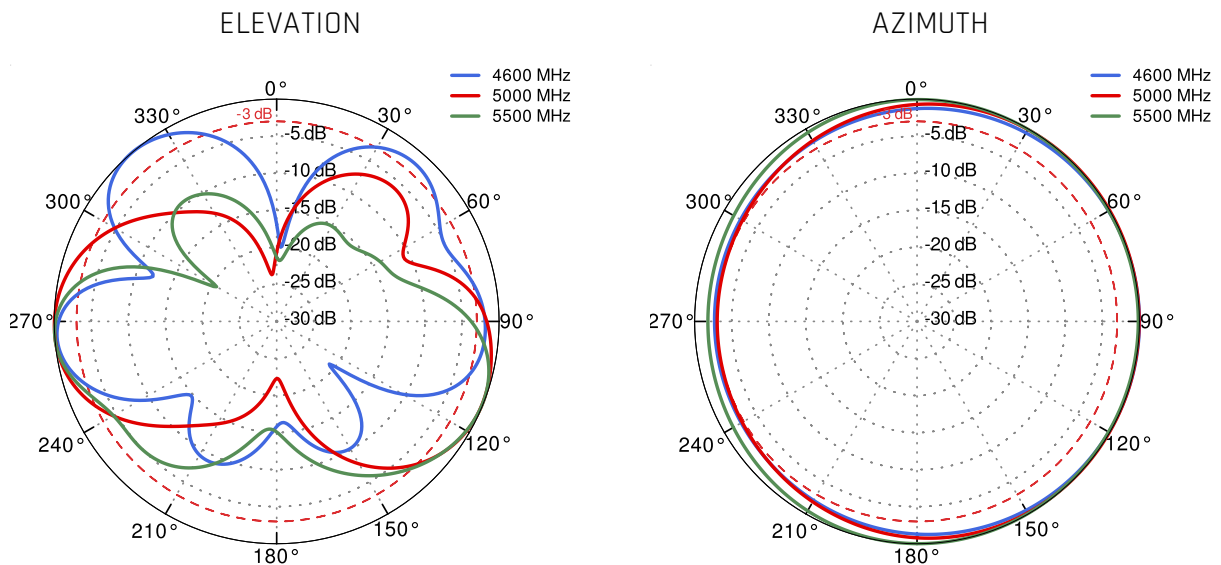

Wi-Fi From 2.4 GHz to 6.5 GHz

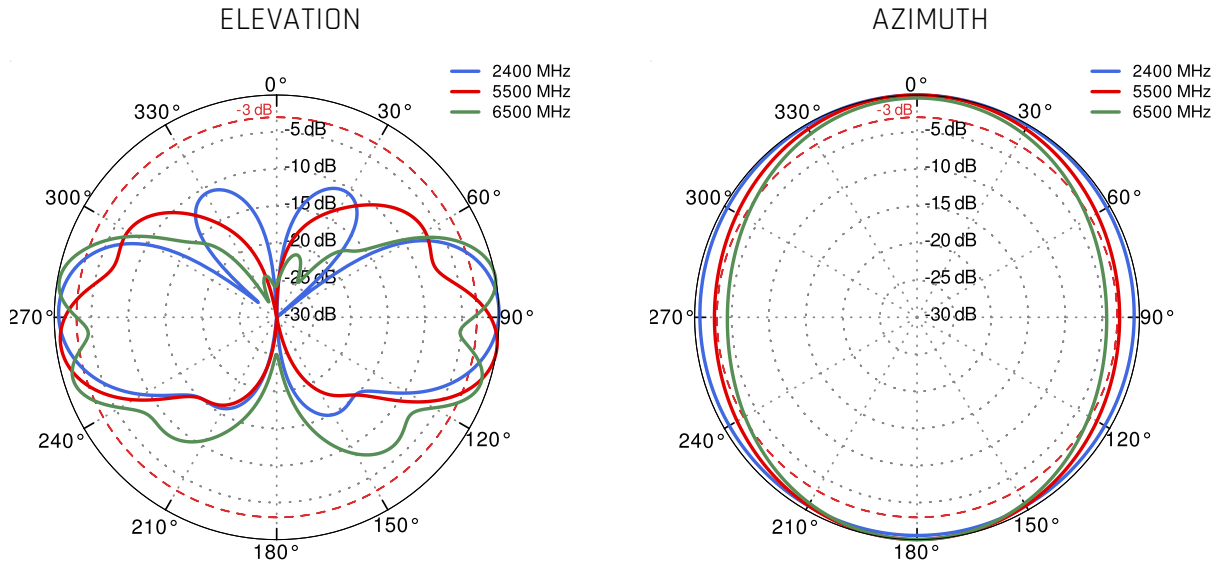

DIMENSIONS

