

2019

Power Logging

To get the job done.

Electrocorder
Portable Energy Recorders

Used Globally by Industry, Education and
Research Professionals

PC Based Temperature Monitors and
Loggers

Temperature Logging
Temperature Analysis

Energy Analysis
Energy Reduction
Energy Audits

Fault Finding
Renewable Testing

Voltage Optimisation
Voltage Analysis

Load Checking
Current Analysis
Industrial Logging

acksen >



Acksen's Electrorecorder data loggers have been helping users in industry since 1997.

Their ease of use, reliability and high quality software has set them apart from the competition.

Continual development ensures Electrorecorders are adapting to the emerging markets of energy auditing, voltage reduction / stabilisation and renewable energy.

acksen >

At Acksen, we like to say... it's what's on the inside that counts.

Who are we:

Measured Soul

At Acksen, we believe in being green, it's something we're passionate about. We're driven to design and manufacture great products that allow you to make accurate, informed decisions about carbon management and corporate environmental obligations.

Where we sell:

Measured Intelligence

Acksen support a network of distributors in North America, Australasia and Europe who supply our data logging equipment to customers who have typical roles and responsibilities around environmental planning, regulation and monitoring of energy use with respect to CO₂ emissions. Typically our customer profile ranges from education and research, general industry, electrical contractors / facilities management through to energy management professionals and power utilities.

What we sell:

Measured Honesty

By providing a personal service we design, develop and deliver dependable products to identify areas of energy use, faults in supply and loading issues; we give you the tools to make decisions around escalating energy pressures.

Our company ethos is to provide easy to use data logging hardware with excellent software analysis at a reasonable cost; our data loggers are classed as entry level equipment which can measure temperature, voltage, current and power factor. The products are robust and provide accurate reliable readings by using a constant sampling technique. All products are supported with lifetime* back to base warranty and free software licensing.

*Refer to website for more information

When we were set up:

Measured Success

Established in 1994, Acksen Ltd has grown from a small local UK based company, to one that is now respected on a number of continents, offering a solid alternative to global brands who service large scale complex solutions for electrical data logging equipment.



Data Analysis Software

Electrosoft and/or TempLog is included free with all loggers; there are no hidden costs with Acksen products, which includes a lifetime* back-to-base warranty.

Our software is used on a Windows PC to set-up your logger.

Many options are available for the interpretation of data, compare graphs, calculations for total energy consumption, Voltage Optimisation, load balancing, CO₂ emissions and much more.

Why invest in a logger that sleeps 99.9% of the time? A utility reclosure voltage sag only lasts 6 cycles ... with other loggers that once out of every 100 seconds, they would miss 99% of the data.

*Refer to website for more information on terms and conditions.

Download and try Electrosoft from our website, there are no catches it's FREE, just the opportunity to see the quality data analysis for yourself.

Load Survey

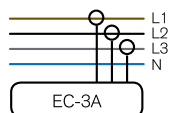

Measuring and Recording Load
Capacity planning and determining peak demand.
Electrosoft gives you detailed analysis at your fingertips.



A range of portable data loggers for measuring current only, or a combination of current, voltage and power factor on AC circuits. DC portable data loggers are also available, some measure Solar Irradiance.

Voltage Reduction

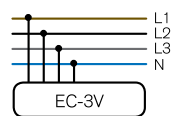

Measuring and Recording Voltage
Voltage reduction, optimisation or stabilisation, all require reliable data recorded over time to determine true pattern of supply and demand in order to estimate possible savings.

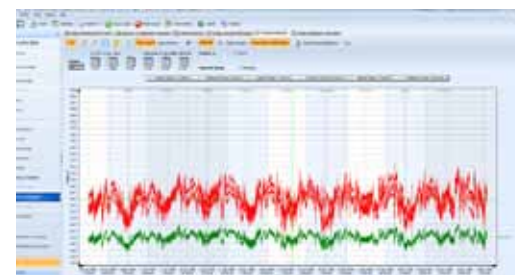

The EC-3V, EC-1V and DC-3V all accurately measure voltage. The AC loggers are extensively used for detection of voltage supply problems by regional electricity companies.

Energy Assessment

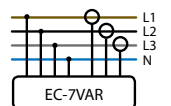

Voltage, Current and Power Factor
Reducing electricity costs and CO₂ emissions is a high priority, start with knowing the facts, record consumption over time.

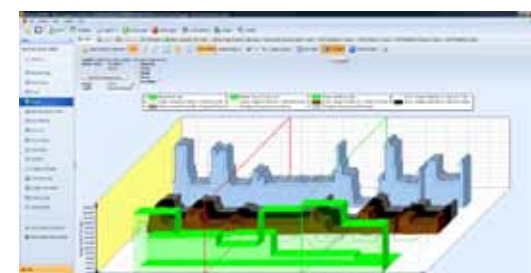

"The Software sold it for me! It has excellent interpretation of the information engineers and energy managers require. Before using the Electrologger I had other data logger products. They don't even compare to Electrologger. Electrologgers are far more advanced. I would absolutely recommend the Electrologger products."

Sean O'Kane, Managing Director at Resourceable Ltd



Power and Appliance Loggers

A range of recorders to monitor loads from single phase domestic appliances to 3 phase 2MVA distribution boards.

All Electrocoders sample every input 16 times per cycle, a cycle is 20ms at 50Hz or 16ms at 60Hz.

At the end of each averaging period, 3 quantities are saved for each channel, the True RMS Average, the Maximum, which is the highest cycle value during the period and the Minimum, lowest cycle value. In comparison to real-time data acquisition systems, data loggers store data in internal memory, the higher the data rates the more memory required.

The recording duration is dependent on the memory capacity of the data logger and the desired averaging period. Electrocoders can record for up to 300 days.

EC-7VAR-RS

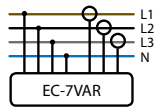

AC Voltage, Current & Cos ϕ (VAR) 3 \emptyset
 Three phase voltage, 600Vac
 Three phase current, two ranges 400Aac & 3kAac
 Power Factor (Cos ϕ), available as IP65/NEMA 12/4
 NEW SMALLER SIZE, 190x120x60mm.



3 \emptyset 3V 3A PF 600V ϕ Rog IP43

IP65/NEMA 12/4 available



EC-2VA

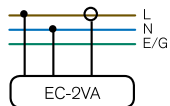

AC Voltage & Current 1 \emptyset
 One voltage channel 300Vac
 One current channel 300Aac
 Sealed to IP65/NEMA 12/4 as standard



1 \emptyset 1V 1A 300V ϕ Rog IP65

NEMA 12/4

BS1363 AS3112 BS546 NEMA 5/15 CEE 7/16

"We undertake energy efficiency audits and needed a recording device to gather the data. The software is user friendly ... it was simple and easy to connect. We are interested in power factor and the actions we take depend on the level of reactive power. The is EC-7VAR worked well for this, I would gladly recommend it"

Ivan Lilkin, Project Manager at Thermoservice Ltd

These loggers can help identify supply issues, determine load related problems, record energy consumption patterns and calculate CO₂ emissions.

Electrosoft software (supplied free with all loggers) will calculate the energy costs over the recording period; it will also extrapolate the data to calculate the costs per week, month, quarter or annum.

Electrocorder data loggers record values independently of a computer; the data is saved to internal memory for later download to a computer. The PC does not need to be present during the data logging process; this makes them ideally suited for applications requiring portability. The data is stored in a non-volatile memory, which means that information will not be lost if the power or internal battery fails.

A number of data loggers are available with various plugs and sockets to record the energy consumption of electrical appliances such as domestic, office or laboratory equipment.

AL-2VA



AC Voltage & Current 1Ø
 One voltage channel 300Vac
 One current channel 15Aac (plug dependent)

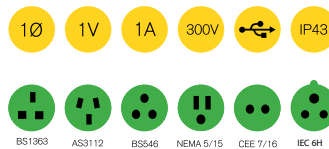

AC Voltage Loggers

For the diagnosis of voltage supply issues and auditing for voltage optimisation, reduction or stabilisation.

Voltage loggers are designed to allow users to record voltage levels on single and three phase systems.

Electrocorders are used extensively by regional power distribution utilities and have become the product of choice for those electrical professionals involved in site surveys for proposed voltage optimisation installations.

Please Note: Voltages leads are available in various colours (for example USA, Canada, Australia) - specify at time of ordering. Images show IEC colours.

"We use and actively encourage our partners to use Acksen's Datalogger. It's a perfect choice for us because it is easy to use, robust and reliable in terms of data analysis and data recovery. The purchase price of the device and the quality of the software provided free with the device are also key factors in our commitment to and choice of the Acksen product."

powerPerformer UK

EC-3V

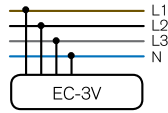

AC Voltage 3Ø
Three phase; 600Vac (L1, L2 & L3 to Neutral)
With phase rotation checker
Available as IP65/NEMA 12/4



3Ø 3V 500V USB IP43

IP65/
NEMA 12/4
available

SL-3V

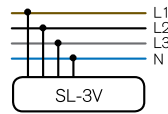

AC Voltage 3Ø
Three phase; 500Vac (L1, L2 & L3 to Neutral)
145x89x45mm (6"x4"x2")



3Ø 3V 500V USB IP43

EC-2V

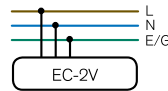

AC Voltage 1Ø
Two channel 300Vac
Live/Hot to Neutral and Earth/Ground to Neutral
Sealed to IP65/NEMA 12/4 as standard



1Ø 2V 300V USB IP65

NEMA 12/4

BS1363 AS3112 BS546 NEMA 5/15 CEE 7/16

These loggers enable you to determine whether voltage problems exist on supplies to equipment.

The Electrocoder range is extensively used in pre and post installation of voltage optimisation equipment. Electrocoders are also typically used in the monitoring of industrial, light commercial and domestic premises.

As many of these single phase voltage loggers are fitted with standard plugs, they are ideal for use by people who are not skilled electrical professionals.

These single phase voltage loggers once set up may be mailed to site for installation by the nominated representative. Once the recording period is complete, the data logger is repackaged in its soft outer mailing case and returned for data analysis.

The LS-1V interruption data logger records dates and times when a voltage supply is present or absent, it can be connected to lighting or other circuits.

EC-1V

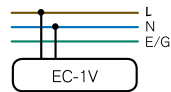

AC Voltage 1Ø
Single phase 300Vac (Live/Hot to Neutral)
Sealed to IP65/NEMA 12/4 as standard

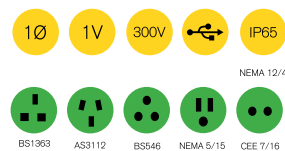

LS-1V

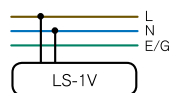

AC Voltage On/Off Logger 1Ø
Single phase 300Vac (Live/Hot to Neutral)
Sealed to IP65/NEMA 12/4 as standard

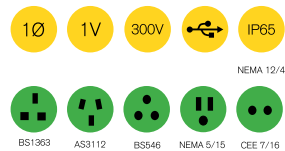

DC and Renewable Energy Loggers

Designed to record voltage, current and solar irradiance, with applications in renewable energy and industrial systems.

Now it is possible to answer the question of return on investment and efficiencies with PV installations. The topic of efficiency is a critical question for many PV system stakeholders.

As time progresses, questions are being asked about return on investment and contributions toward 'Green' obligations in reducing CO₂ emissions.

Acksen's Electrorecorder can offer the answers to questions about efficiency on PV systems.

"It proved quite instructive to display the solar panel output on the same chart and scale as the logger, so helping people to understand what is going on and therefore how to adjust the time when you turn things on in order to maximise the use of your own electricity... We were also able to show people the background electricity use during the night with variations caused by the fridge and freezer going on and off and how there were periods during the day when we had to import electricity because we were not generating enough."

G. Tomlinson Renewables Project Leader.

DC-3VA

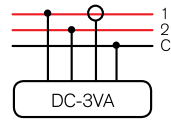

- 2V
 - 1A
 - 300V
 -
 - IP43
- IP65/
NEMA 12/4
available

DC Voltage & Current

Two DC voltage channels; 300Vdc
One DC current channel; bidirectional:-
±10/100Adc, ±30/300Adc, ±100/1kAdc



PV-3

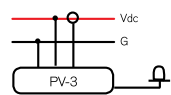

- - Vdc
 - Idc
 - 300V
 - 10A/100A
 -
 - IP43
- IP65/
NEMA 12/4
available

Irradiance, DC Voltage & Current

One channel solar irradiance, 0 -1500W·m⁻²
One DC channel voltage to 300Vdc
One DC current channel; bidirectional:-
±10/100Adc, ±30/300Adc



DC-3V-RS

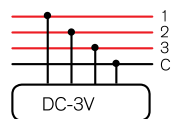

- 3V
 - 60V
 -
 - IP43
- IP65/
NEMA 12/4
available

DC Voltage

Three channels; 60Vdc or 300Vdc, selectable range (D1, D2 and D3 Common)
Available as IP65/NEMA 12/4
Suitable for current logging with appropriate transducer



These loggers record battery charging levels, motors, solar energy generation and patterns of power import and export to the grid.

With Solar PV installations increasing and the realisation that the old myths around the technology being expensive and uncompetitive are disproved, attention for many has turned to the ongoing efficiencies of systems and whether they are delivering what they were designed to.

Until recently assessment of solar installations involved a site survey which took into consideration theoretical irradiation at the site; now owners and investors are asking about ongoing performance of the systems; how much energy is the site consuming and when is it exporting to the grid? This is of particular interest to industrial and domestic owners and investors, as part of on-going energy audits and responsibilities around carbon reduction.

SR-1R

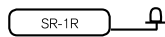

Solar Irradiance

One channel solar irradiance, 0-1500W·m⁻²
Sealed to IP65/NEMA 12/4 as standard



AC Current Loggers

All current loggers come complete with Rogowski coils or Current Transformers (CT's) as appropriate. Current measurement from 0.1Aac to 10kAac, model dependent. We offer single and three phase products.

One of the main benefits of using data loggers is the ability to automatically collect data on a 24-hour basis. Electro-corders are left unattended to measure and record information for the duration of the monitoring period. This gives a comprehensive picture of the electrical conditions.

There are various Electro-corder models available to meet your requirements. From the lowest current of 0.1Aac offered by the CT-1A, up to 10kA per phase with the EC-3A. Contact us for more information.

EC-3A-RS

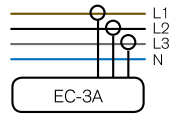

AC Current 3Ø
Three current channels, selectable range 4Aac to 3kAac
Sealed to IP65/NEMA 12/4 as standard
NEW SMALLER SIZE, 190x120x60mm.



NEMA 12/4

CT-3A-RS

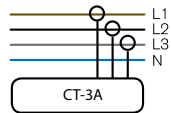

AC Current 3Ø
Three current channels, selectable range 1Aac to 400Aac
Sealed to IP65/NEMA 12/4 as standard
NEW SMALLER SIZE, 190x120x60mm.



NEMA 12/4

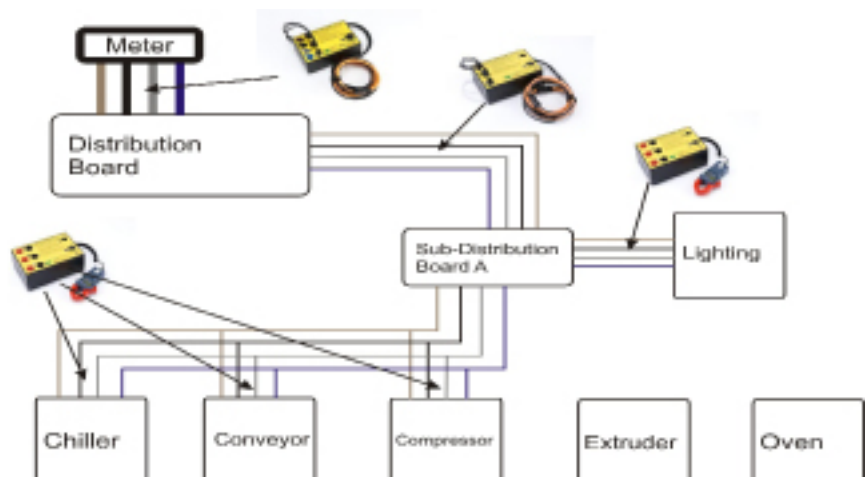

"We need to work out the current to choose the correct size of boiler needed. The Electro-corder gives us all the information that we need to do this. The Electro-corder was very easy to use and I would recommend it."

Bob Hutley, Managing Director at Hutley Electrical Ltd

Electrocorders can record loading on equipment and in turn give you the facts to determine if the equipment is taking current in excess of its rating.

Whether you need to measure current in substation bus-bars, transformers or distribution panels; our range of Electrocorders will give you the information you need.

Perhaps you need to establish if you have capacity for new equipment or expansion, maybe you need determine if existing equipment is running efficiently ... perhaps it should be serviced or replaced?

Electrosoft will give you the data analysis to help you decide.

EC-1A

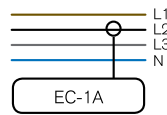

AC Current 1Ø
Single phase; 400Aac, 1kAac, 2kAac or 3kAac
Sealed to IP65/NEMA 12/4 as standard



CT-1A

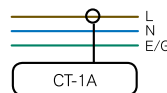

AC Current 1Ø
One current channel; 10Aac, 50Aac or 100Aac
Can be used for earth leakage recording
Sealed to IP65/NEMA 12/4 as standard



Temperature Loggers

All based PC loggers come complete with Software, USB lead, carry case and instructions. Some 'sets' come with temperature probes.

DS-108



8 channel logger for DS18B20 'one wire' digital temperature probes and 8 digital voltage inputs. Allowing you to record temperatures -55C to +125C (-67F to +257F) and the status of digital inputs (0V to 30Vdc). A 5Vdc/400mA output allows external signal conditioning circuitry to be powered.



DS-108
8 x inputs:-
-55C to +125C
-67F to +257F
8 x digital inputs, 0Vdc to 30Vdc

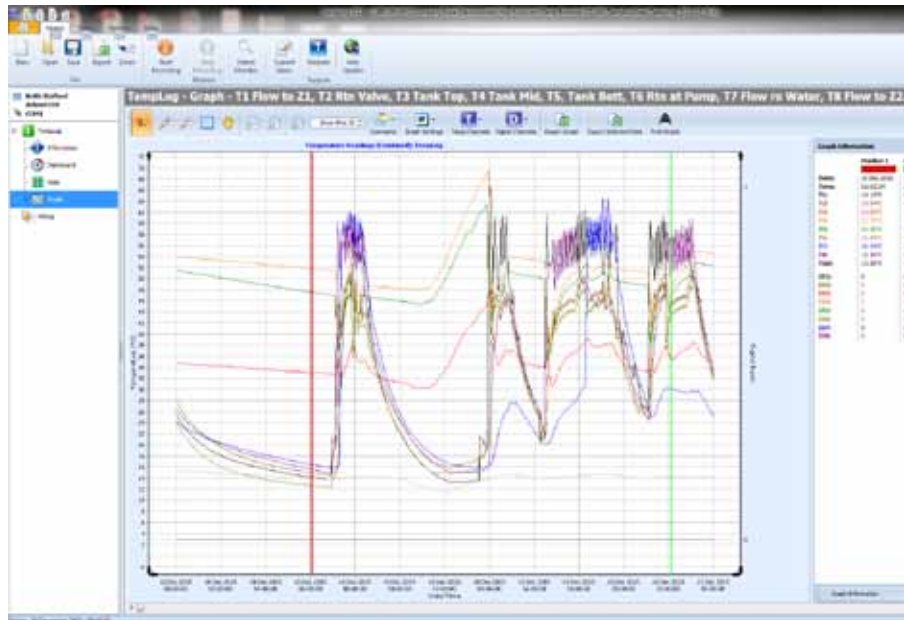

"We wanted to develop a system to control water flow valves, based on various temperatures in a renewable energy heat storage system; the DS-108 was perfect, it recorded the temperatures and the status of valves, boilers, pumps and flow sensors."

Anonymous Research Officer at University of Ulster.
feedback from our website.

Our PC based data monitors and loggers can record temperatures and digital statuses in heating and cooling systems.

Whether you need to measure temperatures in a renewable energy system, heat storage, industrial processes, our loggers give you the data you need in state of the art software.

Perhaps you need to establish if the temperature fluctuates due to a door being opened, a fan stopping or a compressor not starting, our loggers with their digital inputs give you that data. If your logic signals are not 0-30V, you can either make your own conditioning circuit or buy our ready made accessories.

TempLog software will give you the data analysis to help you decide.







Key:

- Single phase
- One channel current
- One channel voltage
- 2 channel DC Voltage
- Two channel voltage
- Three phase
- Three channel current
- Three channel voltage
- 3 channel DC voltage
- Current range to 10A or 100A
- 60 volts maximum
- 300 volts maximum
- 500 volts maximum
- 600 volts maximum
- DC current
- Environmental sealing
- Environmental sealing
- Power factor
- USB comms lead
- Current transformer
- Rogowski coil
- Solar Irradiance
- Europe (CEE 7/16) plug
- North America (NEMA 5/15) plug
- South Africa / India (BS 546) plug
- Australia / New Zealand (AS 3112) plug
- UK (BS 1363) plug
- IEC 6H plug

acksen >

Powerfully Measured

Acksen Ltd
28 Station Road
Whiteabbey
Newtownabbey BT37 0AW
United Kingdom

Tel: +44 (0)28 9020 1050

sales@acksen.com
acksen.com

Version 5.00.01.18

Some of our customers:



SIEMENS



AtlasPipeline

arqiva

THALES

