



# PAPAGO

## Ethernet and WiFi Sensors

- PAPAGO 2PT** to measure 2x Pt100/Pt1000
- PAPAGO PTS** to measure Pt in external system
- PAPAGO 2TH** to measure 2x temperature, humidity and dew point
- PAPAGO 2TC** to measure 2x type K thermocouple



Prague Branch

<b>Sensor A</b>	<b>310.24 °C</b>	!
Upper threshold	270.0 °C	
Lower threshold	240.0 °C	
<b>Sensor B</b>	<b>88.00 °C</b>	
Upper threshold	850.0 °C	
Lower threshold	-200.0 °C	

Current device time: 02/03/2015 13:07:29  
Logged in: Administrator (Logout)  
Papago 2PT ETH ver. 1.2/4  
www.papouch.com

# PAPAGO

## Datasheet

Created: 14.11.2014

Last update: 15.9 2016 13:37

Number of pages: 40

© 2016 Papouch s.r.o.

---

## Papouch s.r.o.

Address:

**Strasnicka 3164  
102 00 Prague 10  
Czech Republic**

Tel:

**+420 267 314 267**

Fax:

**+420 267 314 269**

Internet:

**[www.papouch.com](http://www.papouch.com)**

E-mail:

**[info@papouch.com](mailto:info@papouch.com)**

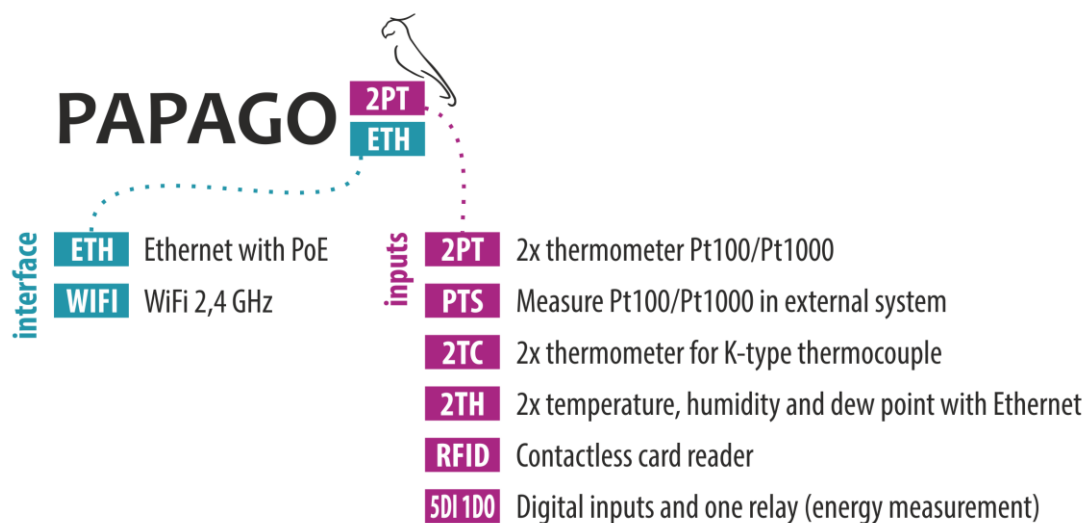

**TABLE OF CONTENTS**

GETTING TO KNOW PAPAGO .....	4	XML .....	23
Applications .....	4	status .....	23
Common Features .....	4	sns .....	23
Communication Options .....	5	SNMP .....	24
Technical Parameters of Individual Modules	5	Objects – variables .....	24
Features .....	6	SNMP objects – general .....	25
CONNECTION.....	7	Traps .....	26
CONFIGURATION.....	9	MODBUS TCP.....	27
Network .....	11	Input Register .....	27
Security.....	12	SPINEL.....	28
E-mail .....	12	Temperature reading .....	28
SNMP .....	14	Reading of name and version .....	30
HTTP GET .....	14	Reading of manufacturing data .....	30
Papago 2PT ETH: Sensor Section.....	16	Automatic message .....	31
Papago PTS ETH: Sensor Section .....	17	INDICATIONS.....	33
Papago 2TC ETH: Sensor Section.....	18	RESET.....	33
Papago 2TH ETH: Sensor Section.....	18	TECHNICAL PARAMETERS .....	34
Other Settings.....	19	2PT .....	34
CONFIGURATION VIA TELNET PROTOCOL..	20	PTS .....	34
Connection .....	20	2TC.....	34
IP address is not known.....	20	2TH – combined humidity and temperature	
IP address is known.....	21	sensor.....	34
Telnet main menu.....	21	2TH – temperature sensor .....	36
Server .....	21	2TH – sensor cable.....	36
Factory Defaults .....	22	Other parameters.....	37
Exit without save .....	22	Default settings of the Ethernet.....	37
Save and exit .....	22	Available designs.....	38

## GETTING TO KNOW PAPAGO

PAPAGO is a family of devices with uniform appearance and communication capabilities. It allows to combine communication interfaces on one side and measuring sensors (inputs) on the other side.



## Applications

- Temperature and humidity measurement in industry, buildings, server rooms and other environments.
- Measurement of temperature for heating systems.
- Monitoring temperatures in warehouses and archives.
- Monitoring the manufacturing proces.
- Monitoring temperature, humidity and reached limits.
- Environmental monitoring via the Internet.
- Measurement for the HACCP system.

## Common Features

- Ethernet or WiFi interface to an internal website and many standard communication protocols.
- Ethernet versions with PoE power supply. This eliminates the need to use an external power supply, but the possibility to connect the AC adapter is available.
- Configuration of WiFi parameters via USB interface.
- Internal memory and real-time clock. Measured data including the time of measurement is automatically stored in the memory in the event that communication is lost. The data is automatically sent after the connection is restored.
- Elegant but robust metal box that can be mounted on a DIN rail. The box bears descriptions that allow connection without having to consult the manual. Also LED indicators for all important states help commissioning.
- The possibility to display, store and analyze data in the Wix program.

**Communication Options**

PAPAGO features different communication options depending on the used interface. PAPAGO can be controlled via a web interface or via software for Windows. Machine data-reading is possible using various standard methods, so PAPAGO can be easily integrated into your existing systems. You can choose the option that is appropriate for your location:

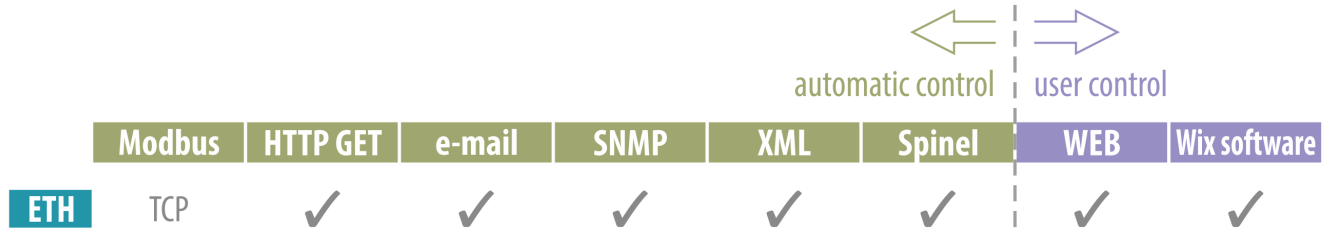

**Machine data-reading:** [Modbus TCP](#), [HTTP GET](#) with encryption, [e-mail](#), [SNMP](#), [XML](#), [Spinel](#)

**User control:** [Web interface](#), Wix software

**Technical Parameters of Individual Modules**

Overview of the properties of the modules of the PAPAGO system. (This manual describes a variant which measures temperature and / or humidity. Other Papago units have separate manuals.)

**2PT** can measure one or two external thermometers Pt100 or Pt1000

- Measuring range 1..... **-200 to +850 °C**; increment 0.1 °C
- Measuring range 2..... -200 to 400 °C; **increment 0.01 °C**
- Measurements per second ... 1, 2 or 5
- Connection method ..... 2, 3 or 4 conductors
- Field (driving) current..... 100, 250, 500, 750, 1000 µA
- Connector ..... screw terminal block



**PTS** can measure one thermometer Pt100 or Pt1000 in an external system

- Measuring range..... -200 to +850 °C; increment 0.1 °C
- Measurements per second ... 1, 2 or 5
- Connection method ..... 3 or 4 conductors (automatically)
- Field current..... 100 to 1000 µA (automatically)
- Connector ..... screw terminal block



Papago PTS with standard firmware is not able to read and relay temperature from systems using pulse measurement. We may be able to modify the firmware for some pulse systems. Please contact us with details about the regulator you use to learn more.

**2TH** can measure temperature, humidity and dew point from two sensors

Each of the two inputs can be fitted with either of these two sensors:



Sensor A .....temperature: -40-123.8 °C; humidity 0-100 %

Sensor B .....temperature: -55 to 125 °C

**2TC**

can measure one or two external thermocouples of type K

Measuring ranges .....-50 to +1350 °C

Measurements per second....1, 2 or 5

Connector .....standard thermocouple connector



## Features

---

- Family of measuring devices with Ethernet or WiFi interface.
- Modern web interface.
- Data reading via a web interface or Wix software.
- Machine data reading via Modbus, HTTP GET, SNMP, XML, e-mail or Spinel protocol.
- The ability to encrypt data in HTTP GET by 128bit encryption.
- Measurements via external thermometers Pt100, Pt1000, thermocouples or combined temperature and humidity sensors. (Sensors are not included.)
- Power supply from PoE (Ethernet versions only) or external source.
- PoE standard according to IEEE 802.3af.
- WiFi 2,4 GHz.
- External DC power supply 11 to 58 V.
- Current consumption typically 72 mA at 24 V.

## CONNECTION

- 1) Ethernet version: Connect the device by a normal uncrossed cable for computer networks to the switch.
- 2) Ethernet version: If the device cannot be powered by the switch via PoE according to the IEEE 802.3af standard, connect an power adapter to the coaxial connector next to the connector for the Ethernet. DC voltage in the range of 11-58 V is expected. (The positive pole is inside, the input for the power supply has reverse polarity protection.)

WiFi version: Connect an power adapter to the coaxial connector next to antenna. DC voltage in the range of 11-58 V is expected. (The positive pole is inside, the input for the power supply has reverse polarity protection.)

- 3) Connect the correct peripherals to the device according to its type:

- 2PT: Connect the Pt100 or Pt1000 thermometer to both or one of the terminals *sensor a* and *sensor b* as shown below.

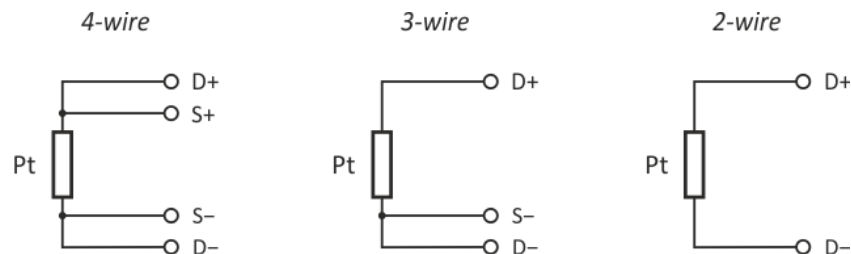

fig. 1 - Connection of the Pt sensor according to the number of connecting wires

- PTS: Reconnect the cables between the existing Pt100/1000 thermometer so that they pass through Papago. This way, it is possible to connect a Pt thermometer that is connected by three or four wires. You do not have to know the original wiring. It is only necessary to observe the order of the wires at terminals IN and OUT as shown in the following figure. The wires will be detected in Papago automatically after connecting.

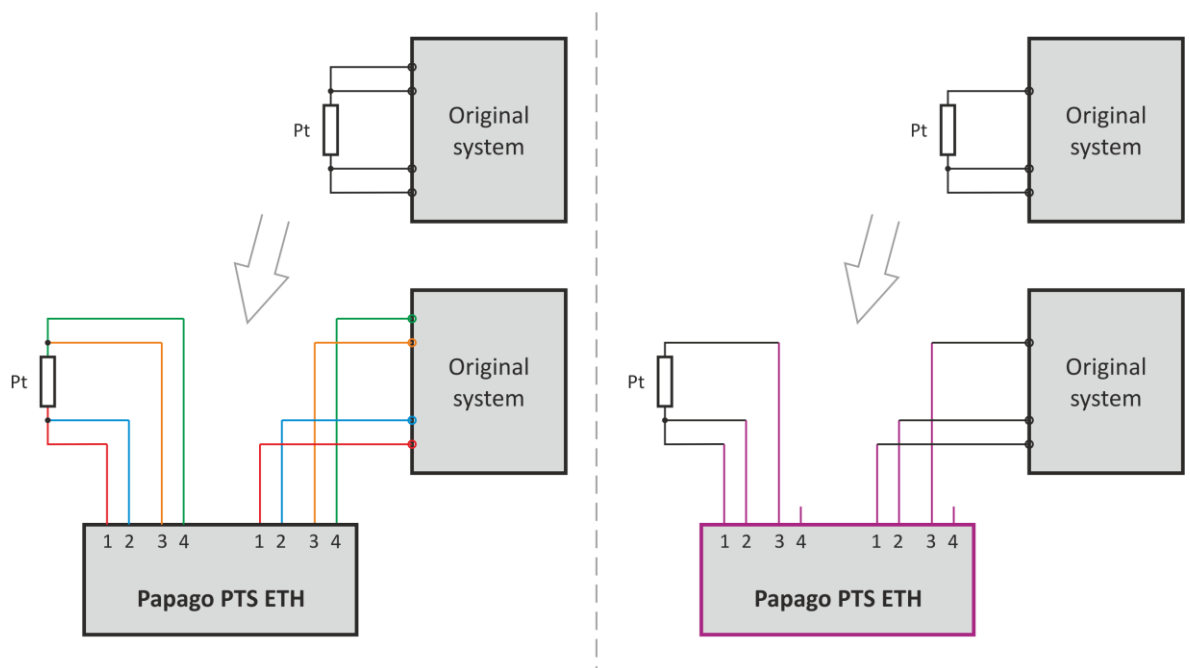

fig. 2 - Connecting Papago into the existing system (via four wires - right, or three wires - left)

- **2TC:** Connect the type K thermocouple to both or one of the terminals *sensor a* and *sensor b*.
  - **2TH:** Connect either a temperature sensor or a combined temperature and humidity sensor to both or one of the terminals *sensor a* and *sensor b*.<sup>1</sup>
- 4) **Ethernet version:** Now it is necessary to set the correct IP address of the device. The default IP address is 192.168.1.254 and network mask 255.255.255.0. If your network is not compatible with this range, set the IP address of the device using [Ethernet Configurator](#).

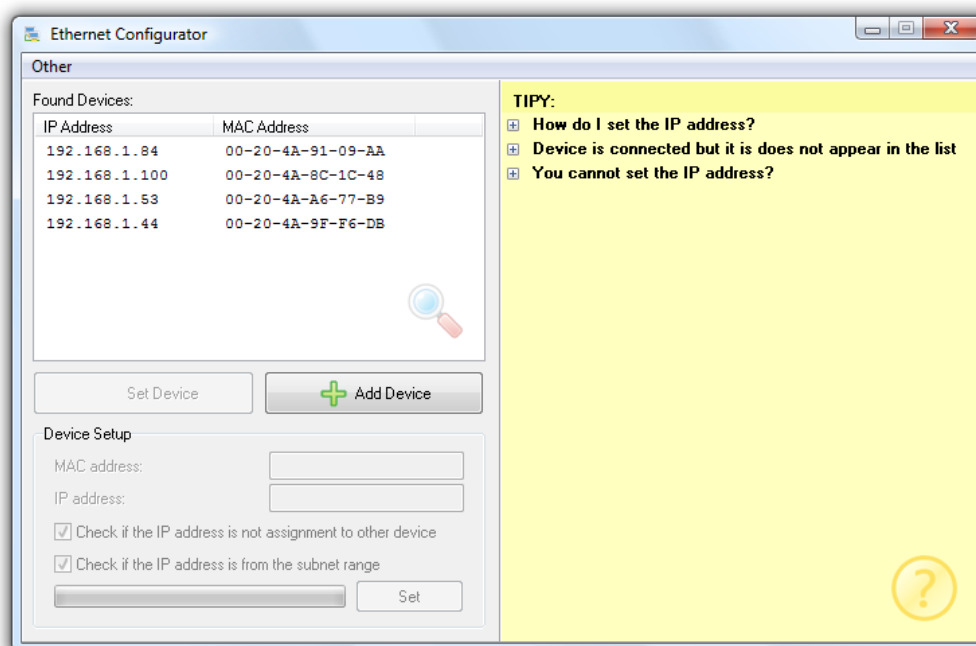

fig. 3 – Ethernet Configurator for setting the IP address

**WiFi version:** Connect your Papago to a windows PC using the supplied micro USB cable.<sup>2</sup> Run Papago WiFi Configurator software, you can download it on papouch.com. Set-up papago to your WiFi network parameters so you can access it from that network.

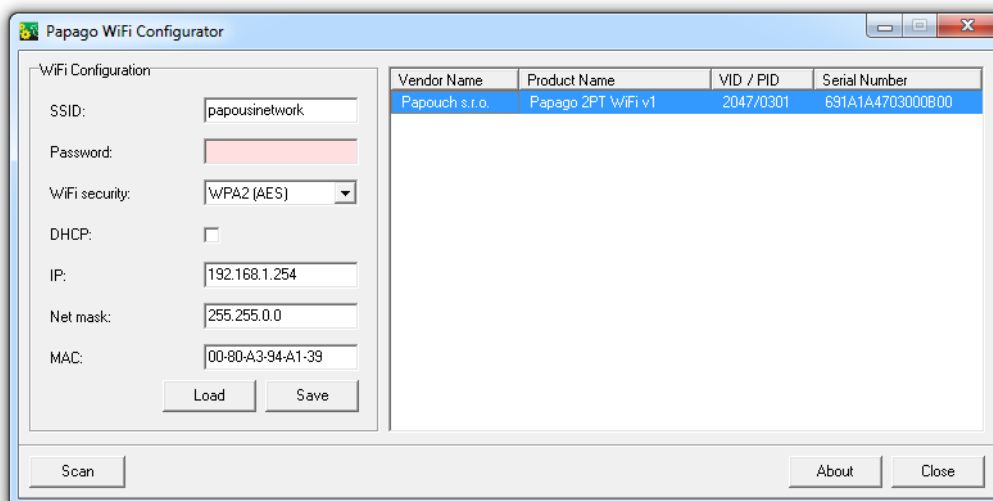

fig. 4 – WiFi configuration via USB

<sup>1</sup> The individual types of sensors are available from papouch.com.

<sup>2</sup> In Windows 7 or higher driver will be installed automatically.



- 5) After setting the address, you can connect to a Web browser at the address specified as follows: *http://192.168.1.254/* (The example is given for the default IP address.)

## CONFIGURATION

Configuration is done via a web interface. The basic network parameters can also be set via Telnet (see page 20). **The web interface** is accessible on the IP address of the device. (The default address is 192.168.1.254.)

After entering the IP address, the main page will appear showing the latest measured values.

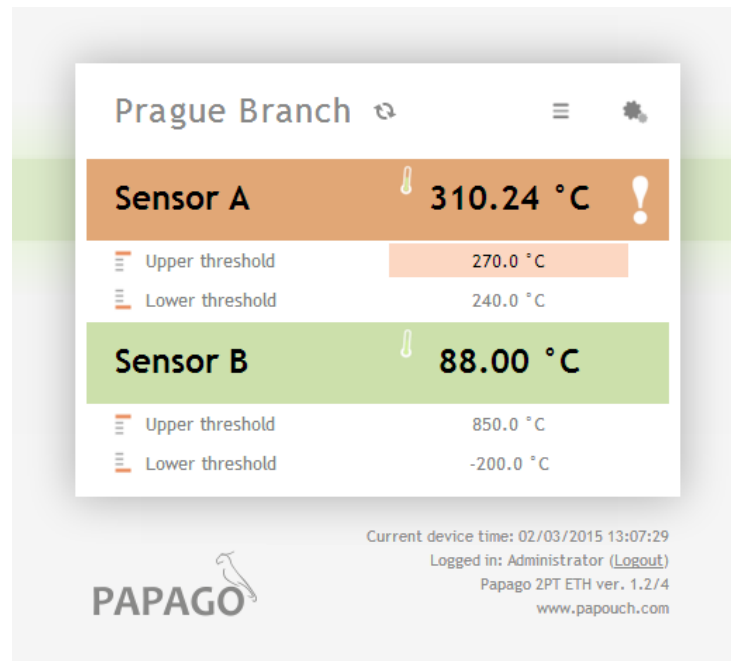

fig. 5 - Values displayed for two sensors – example from 2PT ETH

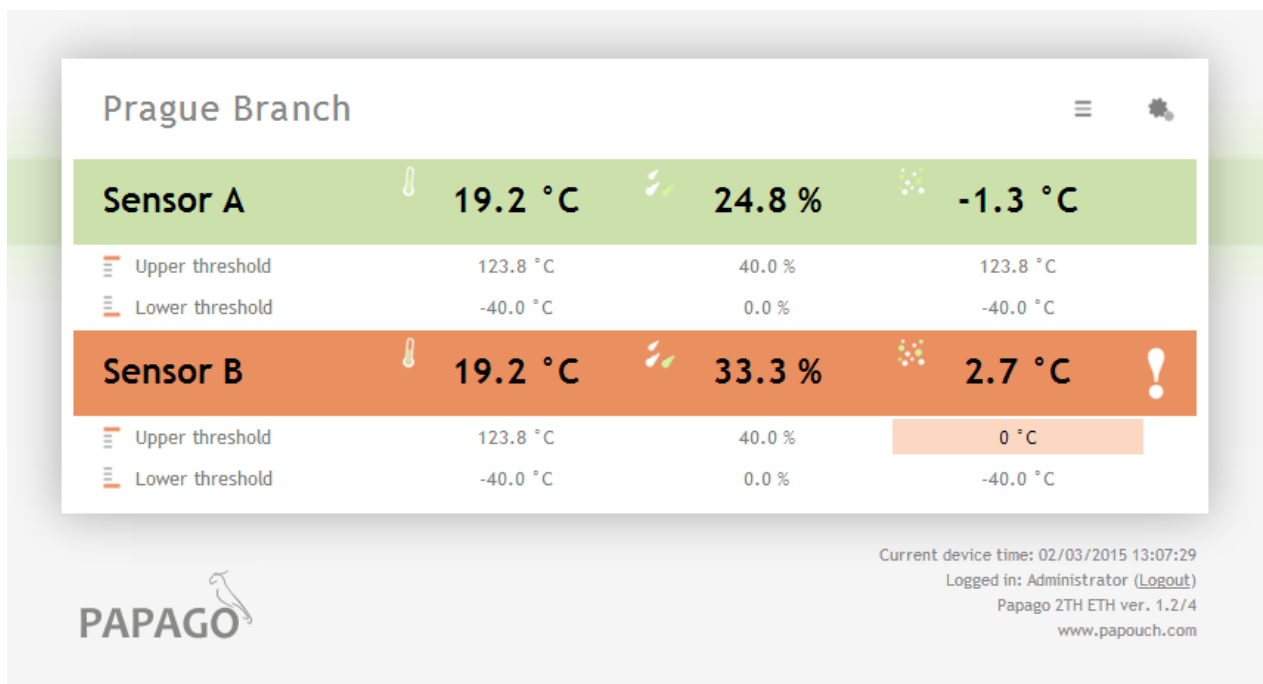

fig. 6 - Three parameters from temperature-humidity sensor connected to connector A (Papago 2TH ETH)

The web interface is secured with a username and password. You can choose a separate password for the user (who can only display the values on the main page) and for the administrator (who can also change settings).

The web interface is optimized for the following browsers (or later version): Mozilla Firefox 29, Internet Explorer 10, Google Chrome 6, Opera 10.62, Safari 1. The Web interface can also be displayed on mobile phones using OS Android 4.2, iOS 7 and Windows Phone 8.1.

The configuration is displayed when you click the icon of gears in the upper right corner. The configuration is divided into sections according to the types of settings and is available in English and Czech.

**PAPAGO**  
from papouch.com

Save Default Reload

### Settings

Type: Papago 2TH ETH      Technical support: www.papouch.com  
Firmware version: 1.0/4      Phone number: +420 267 314 268  
Serial number: 0436/0721  
MAC: 00-20-4A-B5-8D-F1  
Core version: PAPAGO; v1010.01.01; f97;  
Browser: Chrome 39

#### Network

DHCP

Device's IP address

Netmask

Gateway IP address

DNS server's IP address

WEB port

#### Miscellaneous

ModBus Port

Data port (Spinel)

#### Security

User password

Confirm user password

Administrator's password

fig. 7 - Configuraton of Papago

## Network

This section contains the configuration of network parameters.

### Network

DHCP	<input checked="" type="checkbox"/>
Device's IP address	<input type="text" value="192.168.1.45"/>
Netmask	<input type="text" value="255.255.255.0"/>
Gateway IP address	<input type="text" value="0.0.0.0"/>
DNS server's IP address	<input type="text" value="0.0.0.0"/>
WEB port	<input type="text" value="88"/>
<i>Miscellaneous</i>	
ModBus Port	<input type="text" value="512"/>
Data port (Spinel)	<input type="text" value="10001"/>

fig. 8 - network configuration

If the box for assigning addresses via DHCP is ticked, the fields for *Device's IP address*, *Netmask*, *Gateway IP address* and *DNS server's IP address* are reset and upon reloading the settings they are filled again with data obtained from the DHCP server.

If you have a **version with WiFi interface** in the section *Network* is also following parameters:

### WiFi

SSID	<input type="text" value="papousinetwork"/>
Authentication method	<input type="text" value="WPA2 (AES)"/>
Pre-shared Key	<input type="text" value="Keep original password"/>
Re-enter key	<input type="text"/>

fig. 9 - WiFi network parameters

As *Authentication method* is available this options: *Open*, *WEP (open)*, *WEP (shared)*, *WPA (TKIP)*, *WPA (AES)*, *WPA2 (TKIP)*, *WPA2 (AES)*, *WPA2 (Mixed)*.

## Security

---

The section for setting the password of the user (can only access the main page) and the administrator (has access to both the main page and the settings).

### Security

User password	<input type="text" value="Not set"/>
Confirm user password	<input type="text"/>
Administrator's password	<input type="text" value="Keep original password"/>
Confirm administrator's password	<input type="text"/>
Current Administrator's password	<input type="text"/>

fig. 10 - access security settings

After saving, the passwords are no longer displayed for security reasons. The fields for entering the password show *Not set*, if the password has not been entered, or *Keep original password*, if the password has been entered but is not to be displayed.

## E-mail

---

The device can send e-mails if one of the thresholds set for any of the measuring channels has been exceeded.

### E-mail

Send e-mail when the threshold is exceeded	<input checked="" type="checkbox"/>
SMTP server's name	<input type="text" value="smtp.depo.cz"/>
SMTP port	<input type="text" value="587"/>
Host name	<input type="text"/>
Sender's e-mail address	<input type="text" value="xport@depo.cz"/>
Recipient's e-mail address	<input type="text" value="pepa@depo.cz"/>

### SMTP authorization

SMTP server requires verification	<input checked="" type="checkbox"/>
Verification name	<input type="text" value="auth@depo.cz"/>
Verification password	<input type="text" value="Keep original password"/>
Re-enter the password	<input type="text"/>

fig. 11 - settings for sending e-mails

When limits are exceeded, the device always sends two emails, each with one of the limits.  
Examples:

### **Papago 2PT**

#### Example - when limits are exceeded:

Subject..... Papago 2PT ETH\_info\_*[user-defined name]*  
Body..... Temperature Sensor A exceeded lower limit of 19.0 °C. Value is 18.2 °C.  
Subject..... Papago 2PT ETH\_info\_*[user-defined name]*  
Body..... Temperature Sensor B exceeded upper limit of 30.0 °C. Value is 322.1 °C.

#### Example – upon returning in the range:

Subject..... Papago 2PT ETH\_info\_*[user-defined name]*  
Body..... Temperature Sensor A is in range. Value is 19.2 °C.  
Subject..... Papago 2PT ETH\_info\_*[user-defined name]*  
Body..... Temperature Sensor B exceeded upper limit of 30.0 °C. Value is 322.0 °C.

#### Example – email after pressing the TEST button:

Subject..... Papago 2PT ETH\_info\_*[user-defined name]*  
Body..... TEST

### **Papago 2TH**

#### Example - when limits are exceeded:

Temperature Sensor A exceeded upper limit of 26.0 °C. Value is 26.9 °C.  
Humidity Sensor A is in range. Value is 66.7 %.  
Dewpoint Sensor A is in range. Value is 20.2 °C  
Temperature Sensor B is in range. Value is 24.3 °C.  
Humidity Sensor B is in range. Value is 25.1 %.  
Dewpoint Sensor B is in range. Value is 3.1 °C.

#### Example – upon returning in the range:

Temperature Sensor A exceeded upper limit of 26.0 °C. Value is 26.9 °C.  
Humidity Sensor A is in range. Value is 66.7 %.  
Dewpoint Sensor A is in range. Value is 20.2 °C  
Temperature Sensor B is in range. Value is 24.3 °C.  
Humidity Sensor B is in range. Value is 25.1 %.  
Dewpoint Sensor B is in range. Value is 3.1 °C.

## SNMP

---

Here you can configure communication via SNMP used for data collection in large networks.

### SNMP

Allow trap sending	<input checked="" type="checkbox"/>
SNMP manager's IP address	<input type="text" value="145.16.78.121"/>
Send SNMP trap when the threshold is exceeded	<input checked="" type="checkbox"/>
Periodical sending of measured-out values	<input type="text" value="5"/>
Read community name	<input type="text" value="public"/>
Write community name	<input type="text" value="private"/>

fig. 12 - settings for communication via SNMP

For description of SNMP objects see page 23.

## HTTP GET

---

This section is used to set the sending of measured data to a remote server.

### HTTP GET

Sending interval	<input type="text" value="10"/>
WEB server's address	<input type="text" value="example.net"/>
WEB Port	<input type="text" value="80"/>
Folder containing scripts	<input type="text" value="scripts/"/>
Script name	<input type="text" value="get.php"/>
GUID	<input type="text" value="BFLMPSVZ"/>
Encryption Key	<input type="text" value="BrE95Bs5A8hB3t29"/>
<input type="button" value="Send test HTTP GET"/>	

fig. 13 - data sending via HTTP GET

If the sending interval is set to zero, the sending function is turned off. The interval can be set from 0 to 1440 minutes.

If a sensor is set as *Unconnected*, its parameters are not sent in GET.

If you enter an encryption key of 16 characters, the HTTP GET data is encrypted by 128-bit AES cipher (Rijndael), the CFB method.

### GET Format

Example of periodic GET (for Papago with one measured parameter):

```
script.php?mac=0080A393A273&type=Papago%20PT%20ETH
&guid=PAPAGO-TEST-GUID&description=LOG&log_index=4268
&date_time=11/21/2014%20%209:21:00
```

*&T1V1\_value=24.4&T1V1\_units=%B0C&T1V1\_status=0&CH1\_name=Sensor%20A  
&T2V1\_value=322.1&T2V1\_units=%B0C&T2V1\_status=2&CH2\_name=Sensor%20B*

Example of GET after pressing the button in the settings:

*script.php?mac=0080A393A273&type=Papago%202PT%20ETH  
&guid=PAPAGO-TEST-GUID&description=TEST*

Example of encrypted GET after pressing the button in the settings:

*script.php?encrypted\_data=%DC%BD%5D%C1%DE%C4%0A%66%8B%69%0C%6D%8D  
%70%B9%11%EA%8C%19%2A%93%F1%71%87%B7%47%94%77%C7%A2%71%D9%1  
A%3D%BA%21%CF%0D%D5%42%1F%01%23%7B%AF%31%C9%6D%D6%EC%87%C4  
%39%E4%76%84%29%A9%C1%31%74%05%31%3F%96%43%13%3C%73%08%D6%8F  
%56%F5%6C%A2%77%53%C6%A7%10%8F%47%A5%A7%2D%04%9B%58%A0%94*

The following parameters are sent in GET:

*description* .....Indicates a standard GET with measurement (LOG), GET sent when exceeding a limit (WATCH) or a test GET sent when you press the button on the Web (TEST). GET with measurement and GET sent when exceeding a limit contain the same data

*mac* .....MAC address of the device.

*type* .....Type designation of the device.

*guid* .....Unique user-specified text string.

*log\_index* .....The serial number of the record in a circular buffer.<sup>3</sup>

*date\_time* .....Date and time of recording in the format mm/dd/yyyy hh:mm:ss.

*encrypted\_data* This parameter contains the data of encrypted GET.

The following parameters may be given more than once if there are more measured values from one sensor. The first character may be either T (for temperature), H (for humidity) or D (dew point). Thus, Papago 2PT with two temperature sensors, provides these parameters:

*T1V1<sup>4</sup>\_value* ....The first temperature as a decimal number.

*T2V1\_value*.....The second temperature as a decimal number.

*T1V1\_units*.....The unit of the first measured temperature.

*T2V1\_units*.....The unit of the second measured temperature.

*T1V1\_status*.....Status of the first value: the value is OK (0), upper limit exceeded (2), lower limit exceeded (3) invalid value (4).

*T2V1\_status*.....Status of the second value: the value is OK (0), upper limit exceeded (2), lower limit exceeded (3) invalid value (4).

*CH1\_name*.....Channel 1 name.

<sup>3</sup> This number applies if the network connection to the device has been discontinued for some time. After restoring the network connection, all accumulated GETs are sent in the form of a circular buffer. The buffer has a capacity of 200 entries.

<sup>4</sup> The number after the letter T indicates the serial number of the connector on the device. The number after the letter V indicates the serial number of the parameter from the connected sensor..

CH2\_name ..... Channel 2 name.

## Papago 2PT ETH: Sensor Section

Sensors A and B have their own individual sections with identical settings.

### Sensor A

Connected sensor	Pt100
Sensor connection	4-wire
Driving current	750 $\mu$ A
Temperature measurement range	-200 to +850 $^{\circ}$ C
Measuring speed [SPS]	1
Sensor type / standard	IEC 60751 ed. 2 (2008)

### Limit watching

Out of limits watching	<input checked="" type="checkbox"/>	
Limit values	240	730
Hysteresis	0	

fig. 14 - configuration of one of the sensors

It is possible to connect the Pt100 or Pt1000 sensor using 2, 3 or 4 wires.

The names of both sensors can be changed by the user.

The field (driving) current for Pt100 can be 100, 250, 500, 750 or 1000  $\mu$ A. The field (driving) current for Pt1000 can be either 100 or 250  $\mu$ A.

The measuring range is -200 to +850  $^{\circ}$ C (correct to one decimal place) or -200 to +400  $^{\circ}$ C (correct to two decimal places).

The measuring speed of each channel can be 1x, 2x or 5x per second.

Select the desired option depending on the type of sensor you are using.



## Papago PTS ETH: Sensor Section

The PTS version allows you to connect one sensor with the following settings:

### Sensor

Connected sensor	Pt100 ▼
Sensor connection	4-wire
Driving current	742 $\mu$ A
Temperature measurement range	-200 to +850 °C
Measuring speed [SPS]	5 ▼
Sensor type / standard	JIS 1604-1989 ▼

### Limit watching

Out of limits watching	<input checked="" type="checkbox"/>
Limit values	5 125
Hysteresis	0

fig. 15 - configuration of the sensor

It is possible to connect the Pt100 or Pt1000 sensor using 3 or 4 wires. The connection method cannot be configured and is recognized automatically.

Sensor name can be changed by the user.

The field (driving) current for the thermometer cannot be configured and shows the latest measured value.

The measuring range is -200 to +850 °C, correct to one decimal place.

The measuring speed can be 1x, 2x or 5x per second.

Select the desired option depending on the type of sensor you are using.

## Papago 2TC ETH: Sensor Section

---

Sensors A and B have their own individual sections with identical settings.

### Sensor A

Connected sensor	Type K
Temperature measurement range	-50 to +1350 °C
Measuring speed [SPS]	5
<i>Limit watching</i>	
Out of limits watching	<input checked="" type="checkbox"/>
Limit values	800 1200
Hysteresis	0

fig. 16 - configuration of one of the sensors

The only available measuring range is -50 to +1350 °C (correct to one decimal place).

The names of both sensors can be changed by the user.

## Papago 2TH ETH: Sensor Section

---

Sensors A and B have their own individual sections with identical settings.

### Sensor A

Connected sensor	<input type="button" value="Autodetect"/>	Temperature / Humidity
Temperature measurement range	-40 °C to 123.8 °C	
<i>Limit watching</i>		
Watch temperature limits	<input checked="" type="checkbox"/>	
Out of limits watching	-10	80
Hysteresis	0	
Watch humidity limits	<input checked="" type="checkbox"/>	
Out of limits watching	20	80
Hysteresis	0	
Watch dew point limits	<input checked="" type="checkbox"/>	
Out of limits watching	0	10
Hysteresis	0	

fig. 17 - configuration of one of the sensors

By pressing the *Autodetect* button, all settings for Sensor A and/or B are done automatically according to the currently connected sensor(s), above all the right type of the sensor is entered in the field *Connected sensor*.

The names of both sensors can be changed by the user.

## Other Settings

---

This section allows you to set the time, temperature unit, language of the website, etc..

### Other settings

Name of the device	<input type="text" value="Prague Branch"/>
Language	<input style="border-bottom: 1px solid black;" type="text" value="English"/>
Temperature units	<input type="text" value="Celsius [°C]"/>

### Date and time

Synchronize device's time with NTP server	<input checked="" type="checkbox"/>
NTP server's IP address	<input type="text" value="123.120.156.5"/>
Time zone	<input type="text" value="Prague - Czech Republic - CZ (G"/>
Auto daylight saving	<input checked="" type="checkbox"/>
Synchronize device's time with this PC's time	<input type="checkbox"/>

fig. 18 - other settings

The available languages are Czech or English; for temperature units you can choose between degrees Celsius, Fahrenheit or Kelvin.

## CONFIGURATION VIA TELNET PROTOCOL

### Connection

#### IP address is not known

*It is recommended that the IP address should be set using the Ethernet Configurator software (for more information see page 8).*

- 1) Open the window of the cmd command. (In the Windows OS select Start/Run, enter `cmd` in the provided line and click Enter.)
- 2) Make the following entries into the ARP table:
  - a. Type `arp -d` and confirm by Enter. This will delete the current ARP table.
  - b. Use the following command to assign 192.168.1.254 to the module MAC address:  
`arp -s [new_ip_address] [MAC_address_of_device]`  
example: `arp -s 192.168.1.254 00-20-4a-80-65-6e`
- 3) Now open Telnet. (Type in `telnet` and click Enter.<sup>5</sup>)
- 4) Enter `open [new_ip_address] 1` and confirm.
- 5) After a while, the terminal will display an error message saying that connection failed. However, this step is necessary for the module to enter the IP address into its ARP table.
- 6) Connect to the IP address of the module. (Type in `open [IP address in dotted format] 9999` and click Enter.)
- 7) So far you have only entered the configuration mode of the module. The IP address has not yet been set. It must be set in the menu `Server Configuration > IP Address`. If you close the configuration mode without saving the settings and IP address configuration, the whole procedure must be repeated!
- 8) If the entered IP address is valid, the device displays an introductory text ending with:  
**Press Enter for Setup Mode**  
Press Enter within 3 seconds, otherwise the configuration mode will close.
- 9) The device will display a preview of its settings.
- 10) The preview ends with a paragraph called "Change setup:" which lists the groups of parameters that can be configured. Network parameters can be changed in the "Server" section where you can set a new network address and other parameters.

---

<sup>5</sup> In OS Windows Vista, the client for Telnet is not a standard part of the system. Install it using the following procedure:

- a) Open the "Control Panels/Programs and Features" menu.
- b) On the left, click "Enable or disable features of Windows system" (this option requires the administrator to log in).
- c) The "Features of Windows system" window displays. Here tick the "Telnet service Client" field and click Ok. The client for Telnet will be installed.

## IP address is known

- 1) In OS Windows choose Start/Run, enter `telnet` in the provided line and press Enter.<sup>5</sup>
- 2) Connect to the IP address of the module. (Type in `open [IP address in dotted format] 9999` and press Enter.)
- 3) If the entered IP address is valid, the device displays an introductory text ending with:  
**Press Enter for Setup Mode**  
Press Enter within 3 seconds, otherwise the configuration mode will close.
- 4) The device will display a preview of its settings.
- 5) The preview ends with a paragraph called "Change setup:" which lists the groups of parameters that can be configured. Network parameters can be changed in the "Server" section.

## Telnet main menu

Individual items can be chosen using the numbers written next to them. Choose the required number and press Enter.

The menu structure is as follows:

**Change Setup:**

**0 Server**

**...**

**7 Defaults**

**8 Exit without save**

**9 Save and exit**

**Your choice ?**

## Server

Basic Ethernet settings.

This section contains the following parameters:

**IP Address : (192) . (168) . (001) . (122)**

**Set Gateway IP Address (N) ?**

**Netmask: Number of Bits for Host Part (0=default) (16)**

**Change telnet config password (N) ?**

**IP Address***(IP address)*

IP address of the module. The digits must be entered one by one and separated by Enter.

Default value: 192.168.1.254

**Set Gateway IP Address***(set the IP address of the gateway)***Gateway IP addr***(IP address of the gateway)*

In "Set Gateway IP Address" enter "Y" to change the IP address. The system then prompts you to change the Gateway IP address. The digits must be entered one by one and separated by Enter.

**Netmask***(network mask)*

Here you specify the number of bits of the IP address that make up the network part.

The Netmask is set as a number of bits determining the range of available IP addresses of the local network. If, for example, value 2 is entered, the structure of the Netmask is 255.255.255.252. The entered value specifies the number of bits from the right. The maximum is 32.

Default value: 8

Example:

The mask 255.255.255.0 (binary form: 11111111 11111111 11111111 00000000) = number 8.

The mask 255.255.255.252 (binary form: 11111111 11111111 11111111 11111100) = number 2.

**Change telnet config password***(Set the password for Telnet)***Enter new Password***(Enter the password for Telnet)*

This parameter is used to set a new password which is required prior to any configuration via Telnet or via WEB interface (admin password).

For item "Change telnet config password", enter "Y" to change the password. The system then prompts you to change the password.

**Factory Defaults**

By pressing number 7 the device restores the default settings.

The default setting means that all parameters will return to their initial factory settings. The IP address remains unchanged; the web interface port is set to 80.

**Exit without save**

To close the configuration mode without saving the changed parameters.

**Save and exit**

This option saves the changes. If any parameter has been changed, the device is restarted. The restart takes several tens of seconds.

## XML

It is possible to obtain the last measured values, limits (thresholds) and device name from the device in the form of a text file in the XML format. The file is available at *http://[IP-adresa]/fresh.xml* – i.e. for example at <http://192.168.1.254/fresh.xml> for the default settings.

```
<?xml version="1.0" encoding="ISO-8859-2"?>
<root xmlns="http://www.papouch.com/xml/papago/act">
  <sns w-max="30.0" w-min="19.0" val="76.9" name="Sensor A" unit="1" status="2" type="1" id="1"/>
  <sns w-max="30.0" w-min="19.0" val="611.7" name="Sensor B" unit="1" status="2" type="1" id="2"/>
  <status time="11/24/2014 13:54:20" location="NONAME" level="2"/>
</root>
```

fig. 19 – example of XML with actual values

The XML file contains a *sns* tag for each measured parameter as well as the *status* tag:

### status

#### location

User-defined name of the device.

#### time

The current system time of the device in the format *mm/dd/yyyy hh:mm:ss*.

### sns

*For sensors that measure more than one value, this tag also contains the attributes of type, status, unit and val with indices 2, 3, etc., which contain other values (type2, status2, type3,...).*

#### id

The serial number of the measured variable. (The first number is 1.)

#### type

Number 1 (parameters of temperature), 2 (parameters of humidity) or 3 (dew point).

#### status

It describes the status of the measured value. Can show the following values:

- 0 ..... the value is valid and shows the currently measured value
- 2 ..... the measured value exceeds the user-set upper limit
- 3 ..... the measured value exceeds the user-set lower limit
- 4 ..... measurement error or sensor error (damaged sensor or cable)

#### unit

The number represents the code the chosen temperature unit. It can have the following values:

- 0 ..... degrees Celsius
- 1 ..... degrees Fahrenheit
- 2 ..... degrees Kelvin

#### val

The currently measured value as a decimal number, with an accuracy of one- or two-tenths depending on the extent and type of the sensor. (For validity of the value see *status*.)

#### name

The name of the sensor.

**w-min, w-max**

The lower (*w-min*) and upper (*w-max*) limit of the value set by the user. The value is shown as a decimal number with an accuracy of one-tenth.

**SNMP**

The SNMP protocol (version 1) contains objects with individual values. For a detailed description of the objects see below. The MIB table you can import into your SNMP manager can be downloaded from papouch.com.

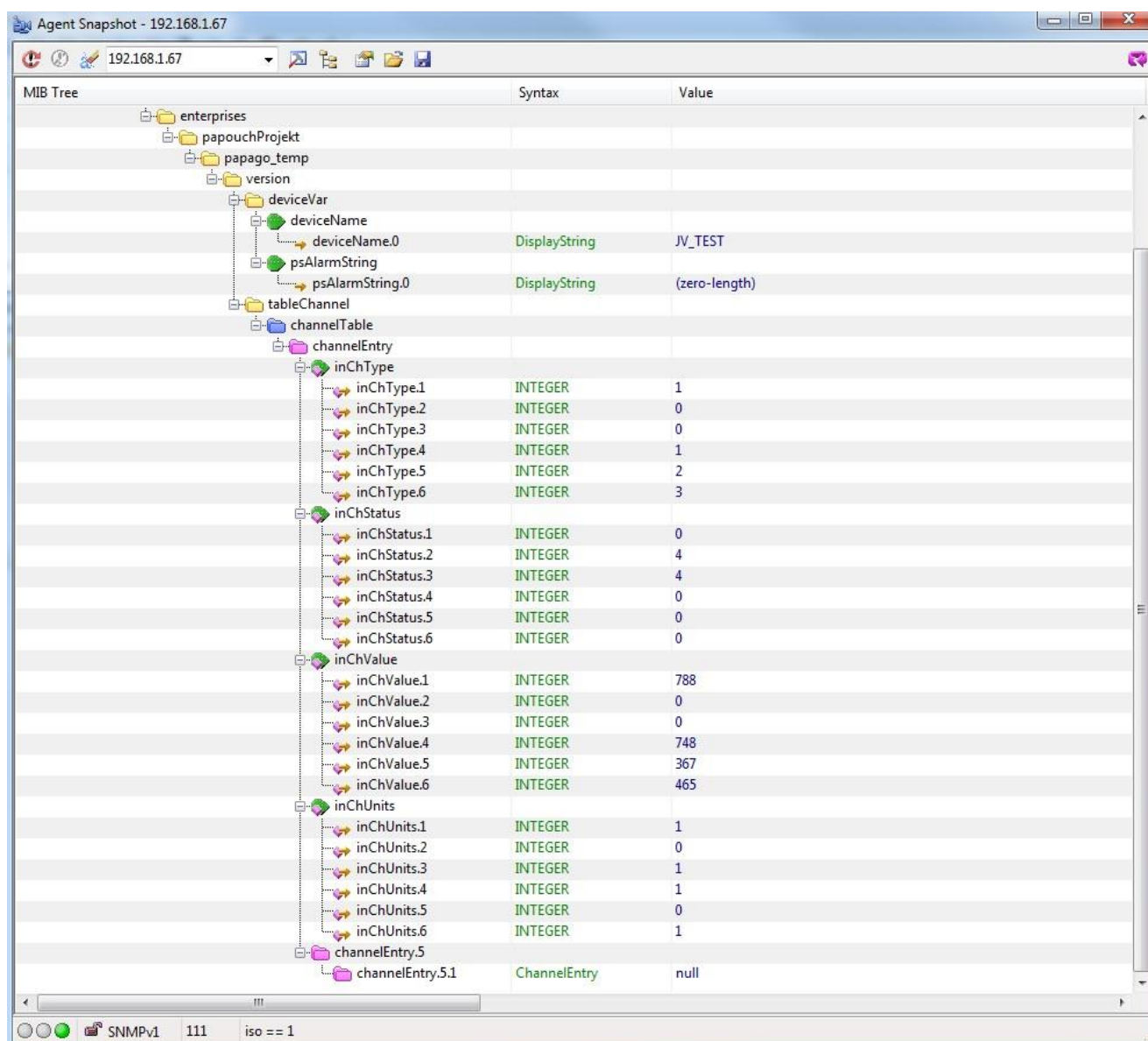

The screenshot shows an SNMP Agent Snapshot window for IP 192.168.1.67. The MIB tree on the left shows the hierarchy: enterprises > papouchProjekt > papago\_temp > version > deviceVar > deviceName > psAlarmString > tableChannel > channelTable > channelEntry > inChType > inChStatus > inChValue > inChUnits > channelEntry.5 > channelEntry.5.1.

Object Name	Syntax	Value
deviceName.0	DisplayString	JV_TEST
psAlarmString.0	DisplayString	(zero-length)
inChType.1	INTEGER	1
inChType.2	INTEGER	0
inChType.3	INTEGER	0
inChType.4	INTEGER	1
inChType.5	INTEGER	2
inChType.6	INTEGER	3
inChStatus.1	INTEGER	0
inChStatus.2	INTEGER	4
inChStatus.3	INTEGER	4
inChStatus.4	INTEGER	0
inChStatus.5	INTEGER	0
inChStatus.6	INTEGER	0
inChValue.1	INTEGER	788
inChValue.2	INTEGER	0
inChValue.3	INTEGER	0
inChValue.4	INTEGER	748
inChValue.5	INTEGER	367
inChValue.6	INTEGER	465
inChUnits.1	INTEGER	1
inChUnits.2	INTEGER	0
inChUnits.3	INTEGER	1
inChUnits.4	INTEGER	1
inChUnits.5	INTEGER	0
inChUnits.6	INTEGER	1
channelEntry.5.1	ChannelEntry	null

fig. 20 - example from Papago 2TH ETH

**Objects – variables****Type**

*Name:* inChType

*Object ID:* 1.3.6.1.4.1.18248.31.1.2.1.1.1.1 až 6<sup>6</sup>

*Description:* The type of this value. It can have one of the following values:

- 0 → Not used.
- 1 → Temperature.



- 2 → Humidity.
- 3 → Dew point.

### Status

*Name:* inChStatus

*Object ID:* 1.3.6.1.4.1.18248.31.1.2.1.1.2.1 to 6<sup>6</sup>

*Description:* The status of this value. It describes the current status of the measured value. It can have one of the following values:

- 0 → The value is valid and within the limits.
- 1 → The value has not yet been measured.
- 2 → The value is valid and exceeds the upper limit.
- 3 → The value is valid and exceeds the lower limit.
- 4 → The value is invalid – measurement error.

### Measured value

*Name:* inChValue

*Object ID:* 1.3.6.1.4.1.18248.31.1.2.1.1.3.1 to 6<sup>6</sup>

*Description:* The measured value as an integer. To obtain the real value, divide by ten.

### Unit

*Name:* inChUnits

*Object ID:* 1.3.6.1.4.1.18248.31.1.2.1.1.4.1 to 6<sup>6</sup>

*Description:* Unit of the value. May contain one of the following values:

- 0 → degrees Celsius.
- 1 → degrees Fahrenheit.
- 2 → degrees Kelvin.
- 3 → percentage (humidity)

## SNMP objects – general

---

The following two objects relate to the entire device.

### Device name

*Name:* deviceName

*Object ID:* 1.3.6.1.4.1.18248.31.1.1.1.0

*Description:* User-defined device name.

### Alarm text

*Name:* psAlarmString

*Object ID:* 1.3.6.1.4.1.18248.31.1.1.2.0

*Description:* Text of the alarm message sent when a threshold is exceeded.

---

<sup>6</sup> The ID of the objects shows the values from sensors A and B arranged one after another. First A, then B. The values are arranged in the order of temperature, humidity, dew point, i.e. there are 2 or 6 objects.

**Traps**

---

**Trap 1 – Value is outside the limits**

The trap contains the measured value and the limit that was exceeded.

The trap is only sent when one of the limits has been exceeded. The trap can only be delivered to a properly configured IP address of a PC with the SNMP manager.

**Trap 2 – Current measured values**

The trap contains all current values as well as the name of the device set by the user.

The trap is sent only if a non-zero frequency of sending has been set.

## MODBUS TCP

For the initial configuration of the address, etc. it is recommended to use, for example, the ModbusConfigurator program, which can be downloaded here:

<http://www.papouch.com/cz/website/mainmenu/software/modbus-configurator/>

## Input Register

Input Register contains the currently measured data from both sensors in several formats..

Address	Access	Function	Name
<b>Sensor 1 – head</b>			
0	read	0x04	<b>Status</b> Contains the status of the sensor. Possible values: 0 = this sensor is not used (set to Not Connected in the configuration) 1 = this sensor is used for measuring
1, 2	read	0x04	<b>Date and time</b> Date and time of the device in the format of NTP.
<b>Sensor 1 – the first parameter (temperature)</b>			
10	read	0x04	<b>Status of the measured values</b> Status of the measured values. Options: 0 = the measured value is within the measuring range 2 = exceeded upper limit of the measuring range (overflow) 3 = exceeded lower limit of the measuring range (underflow) 4 = the measured value is invalid
11	read	0x04	<b>Value in the form of signed integer</b>
12	read	0x04	<b>Value in the float format</b> The upper two bytes.
13	read	0x04	<b>Value in the float format</b> The lower two bytes.
14	read	0x04	<b>Unit</b> The unit in which information is stored in the previous registries. 0 = °C, or % for humidity 1 = °F 2 = K
<b>Sensor 1 – the second parameter (humidity)</b>			
20 to 24			
<b>Sensor 1 – the third parameter (dew point)</b>			
30 to 34			
<b>Sensor 2</b>			
from 100			

**SPINEL**

The device contains the standard Spinel protocol (format 97) for communication via the TCP data channel. [Spinel Terminal](#) has been designed for comfortable communication via Spinel.

index	time	data
0	14:05:59.010	2A 61 00 05 31 02 F3 49 0D
1	14:05:59.018	2A 61 00 25 31 02 00 50 61 70 61 67 6F 20 32 50 54 20 45 54 48 3B 20 76 31 30 31 30 2E 30 31 2E 30 31 3B 20 66 39 37 EB 0D
2	14:06:07.369	2A 61 00 06 31 02 58 01 E2 0D
3	14:06:07.378	2A 61 00 1A 31 02 00 01 01 01 80 00 00 FB 41 C9 7C 81 20 20 20 20 32 35 2E 31 1C 0D
4	14:06:21.483	2A 61 00 05 31 02 FA 42 0D
5	14:06:21.484	2A 61 00 07 31 02 06 03 F2 3F 0D
6	14:07:14.566	2A 61 00 57 31 04 0F 58 31 31 2F 32 35 2F 32 30 31 34 20 31 34 3A 30 37 3A 33 32 01 01 01 81 00 20 20 20 20 20 20 20 B0 43 00 BD 41 97 79 6B 20 20 20 20 20 20 31 38 2E 39 02 01 01 82 00 20 20 20 20 20 20 20 B0 43 0C 95 43 A1 0E 49 20 20 20 20 20 33 32 32 2E 31 63 0D
7	14:07:20.156	TCP/IP client socket - disconnecting
8	14:07:20.166	TCP/IP client socket - disconnect
9	14:19:35.451	device is gone - serial, parallel - COM8

fig. 21 - communication with the device using the Spinel Terminal program

Summary of implemented instructions:

**Temperature reading**

This instruction reads the current measured values. The values are converted to the currently selected temperature unit. The measured values are returned as a sign integer, as a value in the float format and as an ASCII string.

**Request:**

Instruction code: 58H

Parameters: (sensor)

sensor	Sensor No.	length: 1 byte
The number of the sensor to be read. It is possible to choose 01H (sensor a) or 02H (sensor b).		

**Response:**

Acknowledgement code: ACK 00H

Parameters: {(sensor<sub>1</sub>)(variable<sub>1</sub>)(type<sub>1</sub>)(status<sub>1</sub>)(unit<sub>1</sub>)(unita<sub>1</sub>)(value<sub>1</sub>)} {...}

sensor	Sensor No.	length: 1 byte
This bytes indicates the sensor number and applies to all subsequent bytes until the next <i>chn</i> byte. This means that the following bytes belong to the channel with that number. It is numbered from 01H.		

variable	Variable No.	length: 1 byte
The number of the variable from the given sensor. Numbered from 01H.		

type	Variable type	length: 1 byte
The type of the variable can have one of the following values:		
	00H .....	not defined
	01H .....	temperature
	02H .....	humidity
	03H .....	dew point

status	Status of the measured value	length: 1 byte
The status of the measured value for the channel with the number given in the previous <i>chn</i> .		
bit 0 (LSb)	0 = the <b>lower limit of the monitored range</b> was not exceeded	
	1 = the lower limit of the monitored range was exceeded	
bit 1	0 = the <b>upper limit of the monitored range</b> was not exceeded	
	1 = the upper limit of the monitored range was exceeded	
bit 2	0 = the <b>lower limit of the measuring range</b> was not exceeded	
	1 = the lower limit of the measuring range was exceeded	
bit 3	0 = the <b>upper limit of the measuring range</b> was not exceeded	
	1 = the upper limit of the measuring range was exceeded	
bit 7 (MSb)	0 = the measured value is invalid	
	1 = the measured value is valid	

unit	Unit	length: 1 byte
Unit code: 0 for °C, 1 for °F or 2 Kelvin.		

unita	Unit in ASCII string	length: 10 bytes
Unit Code as a right-aligned ASCII string. For example °C, °F, etc.		

value	Measured value	length: 16 bytes
The measured value from the channel with the number given in the <i>chn</i> byte.		
The values are sent simultaneously in three different formats. The first is a 16bit sign value (integer in the form of MSB:LSB), followed by two values converted for the current range based on the current setup: in the 32 bit float format according to IEEE 754 <sup>7</sup> and in the ASCII format. The values are given in the aforementioned order.		
<i>Example:</i>		
The value of 9215.85 is expressed as follows:		
0AH, 58H, 46H, 0FH, FFH, 66H, 20H, 20H, 20H, 39H, 32H, 31H, 35H, 2EH, 38H, 35H		
INT part: 0AH, 58H (2648)		
IEEE 754 part: 46H, 0FH, FFH, 66H		
ASCII part: 20H, 20H, 20H, 39H, 32H, 31H, 35H, 2EH, 38H, 35H ( 9215.85)		

### Examples:

Request – read channel 1:
2AH, 61H, 00H, 06H, 31H, 02H, 58H, 01H, E2H, 0DH
Response:
2AH, 61H, 00H, 1AH, 31H, 02H, 00H, 01H, 01H, 01H, 80H, 00H, 00H, EEH, 41H, BEH, D6H, C3H, 20H, 20H, 20H, 20H, 20H, 32H, 33H, 2EH, 38H, 93H, 0DH
The value measured on channel 1 was 21,74.
Channel number: 01H
Variable number: 01H
Variable type: 01H
Value status: 80H
Unit: 00H

<sup>7</sup> The description of the IEEE 754 standard is available here: [http://en.wikipedia.org/wiki/IEEE\\_754](http://en.wikipedia.org/wiki/IEEE_754)

INT part: 00H, EEH (5434)  
 IEEE 754 part: 41H, BEH, D6H, C3H  
 ASCII part: 20H, 20H, 20H, 20H, 20H, 00H, 32H, 33H, 2EH, 38H (21.74)

## Reading of name and version

Reads the name of the device, software version and the list of possible communication formats. Set by the manufacturer.

### Request:

*Instruction code:* F3H

### Response:

*Acknowledgement code:* ACK 00H

*Parameters:* (string)

string	Name and version	length: 1 byte
	Papago 2PT ETH; v1010.01.01; f97	
In addition to the information described above, the string can also contain other information in sections introduced by a semicolon, space and a small letter to determine which information follows.		

### Examples:

<b>Request:</b>
2AH, 61H, 00H, 05H, 31H, 02H, F3H, 49H, 0DH
<b>Response:</b>
2AH, 61H, 00H, 25H, 31H, 02H, 00H, 50H, 61H, 70H, 61H, 67H, 6FH, 20H, 32H, 50H, 54H, 20H, 45H, 54H, 48H, 3BH, 20H, 76H, 31H, 30H, 31H, 30H, 2EH, 30H, 31H, 2EH, 30H, 31H, 3BH, 20H, 66H, 39H, 37H, EBH, 0DH,

## Reading of manufacturing data

This instruction reads the manufacturing data of the device.

### Request:

*Instruction code:* FAH

### Response:

*Acknowledgement code:* ACK 00H

*Parameters:* (product\_number)(serial\_number)(other)

<b>product_number</b>	length: 2 bytes
Product number. For a device number 0227.00.03/0001 this number is 227.	
<b>serial_number</b>	length: 2 bytes
Serial number. For a device number 0227.00.03/0001 this number is 1.	
<b>other</b>	length: 4 bytes
Other manufacturing information.	

**Examples:**

Request:
2AH, 61H, 00H, 05H, FEH, 02H, FAH, 75H, 0DH

**Automatic message**

This response is generated when the preset limits are exceeded or when the measured value exceeds the physical range of the sensor. The message may contain information about one or more channels.

*Acknowledgement code:* ACK 0FH

*Parameters:* [event][time] {[sensor][variable][type][status][unit][unitA][value]} {...}

<b>event</b> Number of the event source	length: 1 byte
This byte specifies the event source. It can be used to distinguish the automatic message sent when the limits or measuring range are exceeded from other automated messages from the device. The value of this byte is 30H.	
<b>time</b> time of the event	length: 19 bytes
Time of the event as a string in the format <i>mm/dd/yyyy hh:mm:ss</i>	
<b>sensor</b> sensor number	length: 1 byte
The serial number of the sensor the following bytes belong to. Numbering starts from 01H.	
<b>variable</b> variable number	length: 1 byte
The serial number of a variable from one sensor, used to distinguishing between different variables obtained from one sensor, if the sensor provides more than one. Numbering starts from 01H.	
<b>type</b> variable type	length: 1 byte
The type of the variable can have one of the following values: 00H .....not defined 01H .....temperature 02H .....humidity 03H .....dew point	
<b>status</b> Status of the measured value	length: 1 byte
bits 0 to 3 (lower nibble)	0000 = the measured value is within the measuring range
	0001 = the lower limit of the monitored range was exceeded
	0010 = the upper limit of the monitored range was exceeded
	0100 = the lower limit of the physical range of the A/D converter was exceeded
	1000 = the upper limit of the physical range of the A/D converter was exceeded
bit 7 (MSb)	0 = the measured value is invalid

1 = the measured value is valid

**unit**  
unit ID length: 1 byte

The numerical designation of the unit:  
 00H ..... °C  
 01H ..... °F  
 02H ..... K

**unitA**  
unit as a string length: 10 bytes

A right-aligned string designating the selected unit. For example "°C"

**value**  
measured value length: 16 bytes

The values are sent simultaneously in three different formats. The first is a 16bit sign value (integer in the form of MSB:LSB), followed by two values converted for the current range based on the current setup: in the 32 bit float format according to IEEE 754<sup>8</sup> and in the ASCII format. The values are given in the aforementioned order.

*Example:*  
 The value of 9215.85 is expressed as follows:  
 0AH, 58H, 46H, 0FH, FFH, 66H, 20H, 20H, 20H, 39H, 32H, 31H, 35H, 2EH, 38H, 35H  
 INT part: 0AH, 58H (2648)  
 IEEE 754 part: 46H, 0FH, FFH, 66H  
 ASCII part: 20H, 20H, 20H, 39H, 32H, 31H, 35H, 2EH, 38H, 35H ( 9215.85)

**Example:**

Automatic response:

2AH, 61H, 00H, 57H, 31H, 04H, 0FH, 58H, 31H, 31H, 2FH, 32H, 35H, 2FH, 32H, 30H, 31H, 34H, 20H, 31H, 34H, 3AH, 30H, 37H, 3AH, 33H, 32H, 01H, 01H, 01H, 81H, 00H, 20H, 20H, 20H, 20H, 20H, 20H, 20H, 20H, 20H, B0H, 43H, 00H, BDH, 41H, 97H, 79H, 6BH, 20H, 20H, 20H, 20H, 20H, 20H, 31H, 38H, 2EH, 39H, 02H, 01H, 01H, 82H, 00H, 20H, 20H, 20H, 20H, 20H, 20H, 20H, 20H, 20H, B0H, 43H, 0CH, 95H, 43H, A1H, 0EH, 49H, 20H, 20H, 20H, 20H, 20H, 33H, 32H, 32H, 2EH, 31H, 63H, 0DH

Automatic information about exceeding the lower limit on channel 1 and the upper limit on channel 2.  
 The meaning of the values sent for channel 1:

Instruction No.: 58H  
 ASCII time: 31H, 31H, 2FH, 32H, 35H, 2FH, 32H, 30H, 31H, 34H, 20H, 31H, 34H, 3AH, 30H, 37H, 3AH, 33H, 32H  
 Channel No.: 01H  
 Variable No.: 01H  
 Variable type: 01H  
 Value status: 81H  
 Units numerically: 00H  
 Units in ASCII: 20H, 20H, 20H, 20H, 20H, 20H, 20H, 20H, 20H, B0H, 43H  
 Current value:  
 In the form of INT: 00H, BDH  
 In the form of float: 41H, 97H, 79H, 6BH  
 In the form of ASCII: 20H, 20H, 20H, 20H, 20H, 20H, 31H, 3BH, 2EH, 39H

<sup>8</sup> The description of the IEEE 754 standard is available here: [http://en.wikipedia.org/wiki/IEEE\\_754](http://en.wikipedia.org/wiki/IEEE_754)



## INDICATIONS

### Two LEDs integrated in the Ethernet connector:

Yellow – LINK: is lit when the device is connected by cable to a switch or PC.

Green – ACT: indicates communication over the Ethernet.

### Two LEDs to the left under the Ethernet connector:

Yellow (right): is lit when the connection is established via Spinel or Modbus.

Red-green (left):

- the green light is lit and the red light flashes when the device is working properly and is connected to at least one sensor
- the green and red LEDs are lit when the device works, but is not connected to any sensor
- the red LED is lit to indicate an error

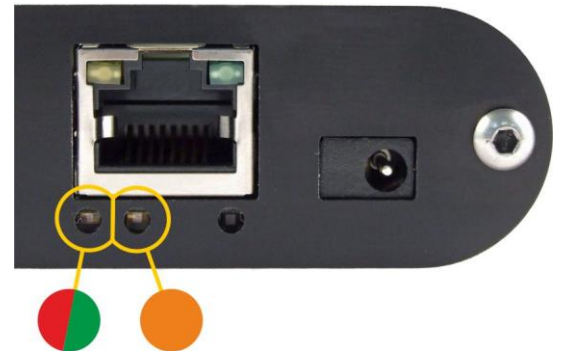

## RESET

Follow the instructions below to restore the default configuration set by the manufacturer. Unlike when the reset is performed via the web interface or using the Telnet protocol (see page 22), the IP address is also reset to the default value of 192.168.1.254.

- 1) Disconnect the device from the power supply.
- 2) Press the button located in a small hole on the right side under the Ethernet connector.
- 3) Turn on the power and wait for about 10 seconds until the yellow light below the Ethernet connector flashes 4 times.
- 4) Release the button.

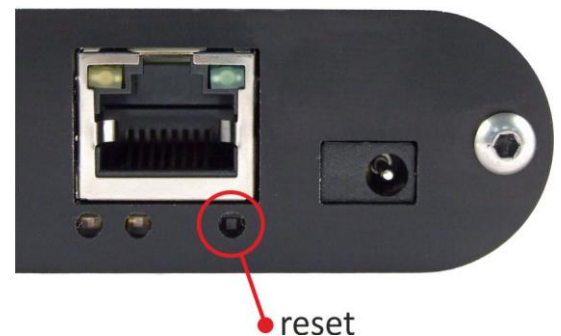

## TECHNICAL PARAMETERS

### 2PT

Sensor types .....2 × Pt100 / Pt1000 (sensor not included)  
 Measuring range 1 .....-200 to +850 °C; increment 0.1 °C  
 Measuring range 2 .....-200 to 400 °C; increment 0.01 °C  
 Measurements per second....1, 2 or 5  
 Connection method .....2, 3 or 4 wires  
 Field current .....100, 250, 500, 750, 1000 µA  
 Connector .....screw terminal block

### PTS

Sensor type.....connected sensor Pt100 or Pt1000 (sensor not included)  
 Measuring range .....-200 to +850 °C; increment 0.1 °C  
 Measurements per second....1, 2 or 5  
 Connection method .....3 or 4 wires (automatically)  
 Field current .....100 to 1000 µA (automatically)  
 Nature of the field current.....constant (not pulse)<sup>9</sup>  
 Connector .....screw terminal block

### 2TC

Sensor type.....2 thermocouples of type K (sensor not included)  
 Measuring ranges .....-50 to +1350 °C; increment 0.1 °C  
 Measurements per second....1, 2 or 5  
 Connector .....standard thermocouple connector

### 2TH – combined humidity and temperature sensor

Important Notice: Polymer sensor is a highly sensitive element that reacts with chemicals. Do not expose even the outer shell of the sensor to chemicals or their vapors (cleaning with alcohol, petrol etc.). Especially organic solvents and compounds can negatively affect the sensor accuracy by as tens of percents RH.

Degree of protection..... IP 54  
 Dimensions ..... aluminium block – 40 × 16 × 10 mm  
 Housing material ..... hardened alloy

<sup>9</sup> Papago PTS with standard firmware is not able to read and relay temperature from systems using pulse measurement. We may be able to modify the firmware for some pulse systems. Please contact us with details about the regulator you use to learn more.

**Humidity sensor**

- Measuring range.....0 % to 100 % RH <sup>10</sup>
- Increment.....1% RH
- Repeatability.....± 0.1 % RH
- Thermal stability .....typically 0.5 % RH a year
- Measuring element.....polymer sensor
- Mechanical design of the sensor .....under a plastic grid on the top of the device

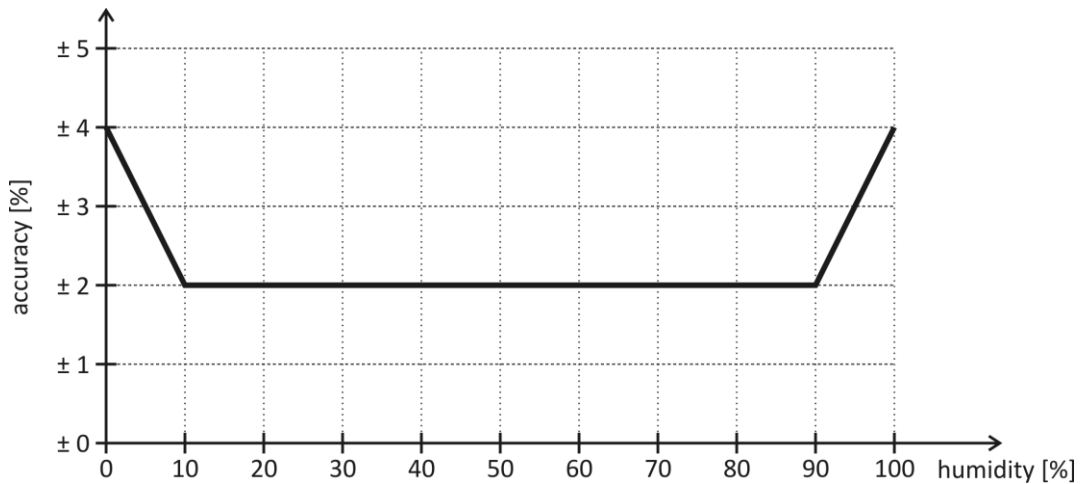

fig. 22 – humidity measurement accuracy

**Temperature sensor**

- Measuring range.....-40.0 °C to +123.8 °C <sup>10</sup>
- Increment.....0.1 °C
- Repeatability.....± 0.1 °C
- Measuring element.....semiconductor sensor
- Mechanical design of the sensor .....under a plastic grid on the top of the device

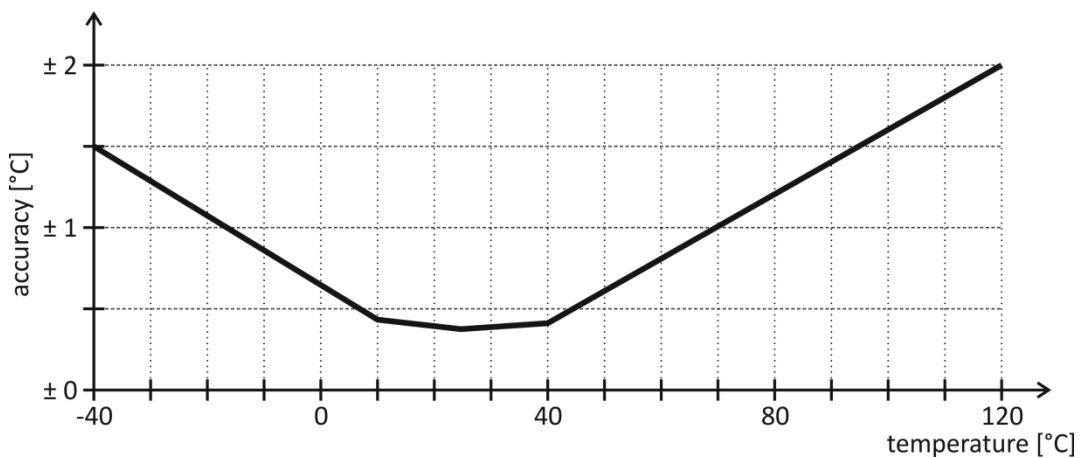

fig. 23 – temperature measurement accuracy

<sup>10</sup> See Working and maximum range of values on page 35!

**Working and maximum range of values**

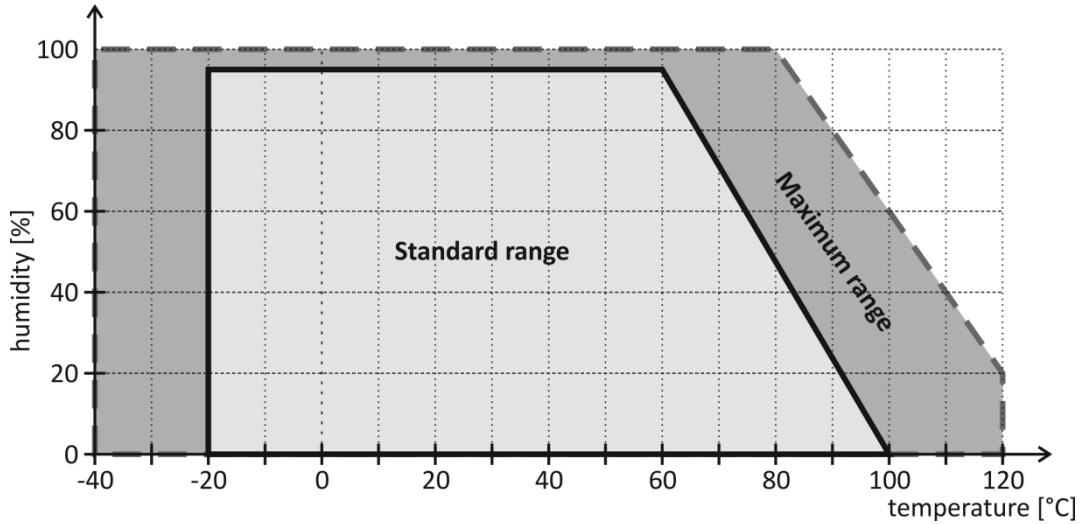

fig. 24 – working and maximum range of the sensor values

- The sensor operates consistently within the range of standard values (see fig. 24). Long-term exposure to any conditions outside this range (especially humidity above 80%) may temporarily shift the measured humidity values (+3% for 60 hours). After returning to the normal range, the sensor slowly returns to the factory set calibration.<sup>11</sup>
- Prolonged exposure to extreme conditions or aggressive chemical vapours can cause premature aging of the sensor and a shift of the measured values.

**2TH – temperature sensor**

Sensor type.....	semiconductor
Measuring temperature range.....	-55 °C to +125 °C
Accuracy.....	±0.5 °C in the range of -10 °C to +85 °C
Temperature drift.....	±0.2 °C per 1000 hours at 125 °C
Dimensions.....	normalized diameter 6 mm, length 60 mm
Housing material.....	hardened alloy
Degree of protection.....	IP68 (permanent immersion into 1m max.)

**2TH – sensor cable**

Cable jacket.....	silicone rubber, blue
Wire insulation.....	FEP polymer
Length.....	standard 3 m (optionally up to 20 meters)
Measuring temperature range.....	-60 °C to +200 °C
Maximum allowable temperature.....	+220 °C

<sup>11</sup> The process of returning to the original calibration can be accelerated by the following procedure:  
 1) For 10 hours, keep the sensor in an environment with temperature of 100-105°C and humidity of 5%.  
 2) For 12 hours, keep the sensor in an environment with temperature of 20-30°C and humidity of 75%.  
 (Humidity of 75% can be achieved, for example, with a saturated NaCl solution.)

Cable diameter .....4.3 mm ( $\pm 0.1$  mm)

The cable shows excellent resistance to moisture, chemicals and carbohydrates.

## Other parameters

---

### Ethernet interface

Connection .....TBase 10/100 Ethernet

Connector .....RJ45

GET encryption.....128 bit AES; Rijndael; CFB method

### WiFi interface

Type.....IEEE 802.11 b/g and IEEE 802.11n (single stream), IEEE 802.11 d/h/i/j/k/w/r

Operating frequency .....2,4 GHz

Antenna connector .....SMA RP

### Clock circuit and internal memory

Clock backup method (RTC) .....capacitor (not replaceable by the user)

RTC backup time after power outage .....5 days  
(if the device was previously connected to a power source  
for at least three hours without interruption)

### Device electronics

PoE power supply.....according to IEEE 802.3af

Power supply from an external source .....11 to 58 V DC (with reverse polarity protection)

Current consumption from ext. source at 15 V ...typically 120 mA

Current consumption from ext. source at 24 V ...typically 72 mA

Current consumption from PoE .....typically 32 mA

Consumption .....typically 1.8 W

Power supply connector .....coaxial 3.8 × 1.3 mm; + inside

Operating temperature range .....-20 to +70 °C

Dimensions (without connectors).....88 × 70 × 25 mm

Housing material.....anodized aluminium

Degree of protection .....IP 30

### Other parameters

Weight .....typically 130 g

### Default settings of the Ethernet

---

IP address .....192.168.1.254

Netmask .....255.255.255.0 (8 bits; mask C)

IP address of the gateway .....0.0.0.0

**Available designs**

---

Mountable on 35 mm DIN rail ..... optional accessory



*fig. 25 – Papago 2TH ETH with DIN rail holder*

*Do not hesitate to contact us if you have any other requirements concerning the design and functions of PAPAGO.*



# Papouch s.r.o.

Data transmission in industry, line and protocol conversions, RS232/485/422/USB/Ethernet/GPRS/WiFi, measurement modules, intelligent temperature sensors, I/O modules, and custom-made electronic applications.

Address:

**Strasnicka 3164  
102 00 Prague 10  
Czech Republic**

Tel:

**+420 267 314 267**

Fax:

**+420 267 314 269**

Internet:

**[www.papouch.com](http://www.papouch.com)**

E-mail:

**[info@papouch.com](mailto:info@papouch.com)**

